

HotTop

COFFEE ROASTER



Model KN-8828P-2K Shown

Owner's Manual

This manual covers models **KN-8828B-2K** and **KN-8828P-2K**

REV. BP-2K v.1.4 June 2012

Manufactured by Chang Yue Industrial Corp.®
No. 170, Chung Lun, Chung Sha Tsun, An Ding Shian
Tainan, Taiwan
Tel: 886-6-593-2311 Fax: 886-6-593-4834
www.hottop.com.tw
Email: hottop@ms12.hinet.net

Hottop USA
25 Katelan Court
Cranston, Rhode Island 02921
Fax: (401) 946-0268
www.hottopusa.com
Email: hottop@hottopusa.com

Information contained herein subject to change without notice



**READ THIS ENTIRE MANUAL
before using this appliance.**

WARNING!

This device is capable of high temperatures. If used without due caution it can constitute a safety hazard. The outer surface will become hot enough to cause very serious burns and the bean roaster has the potential to ignite flammable materials on, in, or near the roaster. The Hottop Coffee Roaster can be operated in such a way as to create a fire hazard by igniting the beans being roasted and/or the chaff (a by-product of the roasting process). Always follow the safety guidelines and usage directions in this manual, and use common sense to avoid these situations

**Read, understand, and follow all
operating instructions and
safety warnings contained in
this manual before operation.
Always follow the safety guidelines
and heed all warnings when using
the Hottop Coffee Roaster**

Table of Contents

I - Important Safety Precautions -----	4	Selecting a Program	28
How To Install The Heat-guard Grills -----	6	Roasting with a Program -----	29
II - Emergency Bean Ejection -----	8	Copying a Program -----	31
III - Coffee Roasting- A Brief History -----	9	Deleting a Program -----	31
You Are On Your Way Back To The Past -----	9	Understanding a Program and Segments -----	32
IV - Introduction To The Roasting Process -----	10	A Sample Program and its Roast -----	33
Recognizing Roast Level -----	10	Modifying a Program -----	34
Sound -----	10	Temperature -----	34
Timing Of The Cracks -----	11	Fan -----	34
Color and Temperature as a Roast Indicator -----	11	Program Name -----	35
V - Basic Roasting and Your First Roast -----	11	Time -----	34
Basic Operation Of The Hottop Coffee Roaster -----	12	Abandon Changes -----	35
VI - Coffee Roasting Color Chart -----	13	Save Changes -----	35
VII - Model KN-8828B-2K -----	14	Changing One Parameter "Quick Programming" -----	35
Understanding The LCD Display -----	14	Advanced Manual Control -----	36
Control Functions -----	15	IX - Cleaning And Care -----	37
Messages -----	15	A. After Each Roast -----	37
Factory Programmed Safety -----	15	B. After 5 To 10 Roasts -----	38
Roast Parameter Changes -----	15	1- Drum Removal -----	38
Range Of Control Adjustments -----	16	2- Replacing The Drum -----	38
Target Time And Remaining Time -----	16	3- Exterior Cleaning -----	39
Target Temperature And Current Temperature -----	16	C - Every Three Months - Interior Cleaning -----	39
Selecting Temperature Measurement Units -----	16	X - Roasting Styles Overview -----	40
Auto Mode -----	17	Cracks, Flavors And Roast Styles -----	40
Modifying Roast Parameters -----	17	Experiment With Roasts -----	41
Storing (Saving) A Roast Profile -----	18	Coffee Varieties And Roast Styles -----	42
Roasting with a Stored Profile -----	18	Central-American, Colombian & African Coffees --	43
Getting the moist from your KN-8828B-2K -----	19	Brazilian, Mexican And Other Mild Coffees -----	43
VIII - Model KN-8828P-2K -----	22	Indonesian Coffees -----	43
Understanding The LCD Display -----	22	Sumatran, Or Sulawesi Coffee. -----	43
Active Buttons Illuminated -----	23	What's Best? You Decide! -----	43
Factory Programmed Safety -----	23	XI - Tips And Hints -----	44
Chaff Tray Safety Switch -----	23	Storing Coffee -----	44
Selecting Operating Mode -----	23	Roasting Tips -----	44
Selecting Temperature Measurement Units -----	23	Dark And Decaf Coffee -----	44
Auto Mode -----	24	Bean Cleaning -----	45
Manual Mode - Roasting with Programs -----	26	When Is It Ready To Drink? -----	45
Segment Time -----	26	How To Taste-test Coffee -----	46
Manual Mode -----	26	My Coffee Doesn't Taste Right To Me -----	46
Segment Temperature -----	27	Keep Records -----	46
Segment Fan Speed -----	27	XII - Resources -----	47
Program Name -----	27	Suppliers Of Beans -----	47
Screen Color -----	27	Environmental Disposal -----	47

MODEL-SPECIFIC INFORMATION IS COLOR-CODED ABOVE AS FOLLOWS:

KN-8828B-2K - Color LCD digital display

KN-8828P-2K - Fully programmable model with LCD Display

The remainder of this manual's contents pertains to all models except where noted in the text.

All information in this manual is ©2007-2012 Chang Yue Industrial Corp.® and Hottop USA. No portion of this manual may be reproduced without the expressed written permission of Chang Yue Industrial Corp.®.

I - IMPORTANT SAFETY PRECAUTIONS

When using this electrical appliance, these safety precautions must always be followed:
SAVE THESE INSTRUCTIONS in a safe place and REFER TO THEM OFTEN

WARNING: Read and Understand All Instructions, Precautions, Labels and Warnings BEFORE Using This Coffee Roaster!



Keep these instructions for future reference and be sure anyone operating the machine reads and understands them before allowing them to use the Coffee Roaster. Feel free to contact your dealer before operating this appliance if you have any questions.

• **Never leave the Coffee Roaster unattended while in operation!**

- Do not bypass, defeat, or remove any safety feature of the Hottop Coffee Roaster.
- The Emergency Eject Knob at the rear of the roaster is designed to be used for emergencies only (see page 8 for details)
- The outer surface can be VERY hot! Do not touch hot surfaces. When necessary, use oven mitts for removing or touching any hot parts. Do not reach over or across the Coffee Roaster while it is in operation. Allow the machine to completely cool before disassembling, moving, or cleaning.
- At the end of the roasting cycle when the beans are ejected into the cooling tray they will be very hot. Do not touch the beans until the cooling cycle has completed!
- The Coffee Roaster should not be used by children or in the presence of children.
- Use the Coffee Roaster only when fully assembled. Never operate the Hottop Coffee Roaster without first attaching the heat protection grillwork. Discontinue use if any part becomes damaged, does not fit properly, or if the machine does not operate properly. Do not attempt to service the machine yourself, but seek repair or replacement from an authorized service center or your dealer.
- The use of accessory attachments other than those supplied or recommended by the manufacturer may cause hazards and can void your warranty.
- This appliance is for indoor, household use only. This appliance is not for commercial use.
- To prevent electric shocks, never use water on or near the machine. Do not use where rain or water can enter the machine. Do not immerse or spray the cord, the plug, or the base with water or other liquids. Other than as specifically described in this manual, do not wash the machine or any part in sink or dishwasher.
- Arrange the cord so that it cannot be caught or tripped over. Do not allow cord to hang over edge of table or counter. Keep cord away from all hot surfaces including those of the machine itself.
- Do not place the Coffee Roaster nor its cord on, in, or near a hot gas or electric burner, or in a heated oven.
- A short power cord has been provided. An extension cord may be used if care is exercised during its use. Use an extension cord rated at 8 amps or more. The cord should be arranged so it will not drape over the counter or table top. Do not use an extension cord longer than is absolutely necessary. Always grab the plug to disconnect the roaster from the wall socket. Never pull on the cord. Disconnect the power cord when the Coffee Roaster is not in use.
- Use both hands to move the appliance. Never move this appliance when it is in operation. Allow appliance to cool completely before moving.
- If the electric circuit is overloaded with other appliances, your Coffee Roaster may not operate properly. This unit should be operated on a separate electrical circuit from other operating appliances.
- To clean the Coffee Roaster follow the included cleaning instructions in this manual. Unplug the unit and allow it to completely cool before doing any cleaning or disassembly. Do all maintenance and cleaning chores only when the machine is unplugged and completely cooled off. Refer to Chapter VIII for more details on "Cleaning and Care".

- Always leave at least eight inches of space around the Coffee Roaster on all sides for proper ventilation when operating and until it has cooled. Keep the machine away from flammable materials such as curtains, towels, walls, furniture, or any other materials. Place on a heat-resistant surface when in use. Do not operate near combustible materials or liquids, nor near any pressurized spray cans.
- Avoid touching moving parts. Never reach into the machine while it is plugged in.
- Operate the Coffee Roaster only in a clean, dust-free area. Dust, dirt, and sprayed liquids can be drawn into the Coffee Roaster and can contaminate the coffee being roasted.
- Use the Coffee Roaster only for roasting coffee beans. Never place any other substances, food or not, in the machine. Use of anything other than green, un-roasted coffee beans in the Hottop Coffee Roaster may create a hazardous condition and will void your warranty.
- If the supply cord is damaged, it must be replaced by the manufacturer, its service agent, or similarly qualified persons in order to avoid a hazard.
- This device is not intended for use by persons (including children) with reduced physical, sensory, or mental capabilities, or lack of experience and knowledge, unless they have been given supervision or instruction concerning use of the appliance by a person responsible for their safety.
- Children should be supervised to ensure that they do not play with the appliance.
-  Caution - Hot Surface. The surfaces are liable to get hot during use.
- The temperature of accessible surfaces may be high when the appliance is operating.
- This appliance is intended to be used in household and similar applications such as:
 - staff kitchen areas in shops, offices, and other working environments
 - farm houses
 - by clients in hotels, motels, and other residential type environments
 - bed and breakfast environments
- Coffee roasting produces smoke which can be a respiratory irritant. Control the smoke so it does not enter the structure. Take care if there are children or elderly in the home or if anyone in the home has respiratory or breathing problems. Avoid breathing the smoke. We recommend that you use the Coffee Roaster in a place where ample ventilation is available- in the kitchen under an efficient range hood which vents outside, or near a window with an exhaust fan.
- Always allow the machine to go through the entire roasting and cooling process (except for hitting the “eject” button to stop a roast early or pulling the emergency eject knob in an emergency). Let the machine turn itself off after each roasting cycle. This will help extend the life of the Hottop Coffee Roaster. NEVER unplug the machine during a roast as it can cause a fire hazard and/or shorten the life of the machine.
- Roasting coffee too dark should be avoided. Just like you can over-cook and burn food on your stove or in your oven, it is possible to over-roast and burn coffee in the Hottop Coffee Roaster. Although numerous safety features have been designed into the Hottop Coffee Roaster to safely perform roasting and cooling cycles, over-roasting can occur. This is more likely to happen when using less than the recommended amount of beans (250 grams) and/or on a setting that is too hot and/or too long.
- Under extreme circumstances, over-roasted beans can catch fire, particularly when the beans are ejected and become exposed to the atmosphere. Always use the indicated amount of beans (250 grams), and always monitor the progress of the roast to prevent over-roasting.
- Extra care must be taken when roasting decaffeinated coffee. The decaffeination process changes the indicators used to judge roast level and over-roasting can result.
- Always have a spray bottle filled with water on hand when roasting to quench a fire if the beans ignite upon ejection. Do not attempt to move the machine if the ejected beans ignite. In the case of ignition, disconnect the machine, use the water-filled spray bottle or fire extinguisher to extinguish the flames, and call emergency services.
- **NOTE:** Some models cannot be restarted until the chaff tray is removed, emptied, and replaced. For all models, empty the chaff tray after every roasted batch. The chaff and coffee bits in the chaff tray will become very hot during roasting. Chaff can ignite during the roasting process and may smolder in the chaff tray. Use great care when disposing of the chaff as it can create a fire hazard, particularly if it is dumped onto other flammable material soon after a roast has concluded.

Identifying a “2K” Hottop Coffee Roaster Model

This manual is written for the KN-8828P-2K and the KN-8828B-2K. These can be easily identified by looking through the roasting chamber Viewing Window. On the rear wall of the roasting chamber, in approximately the three o'clock position, you will see the K-style sensor shown here.



“K” Sensor

Hottop Coffee Roaster Parts Diagram

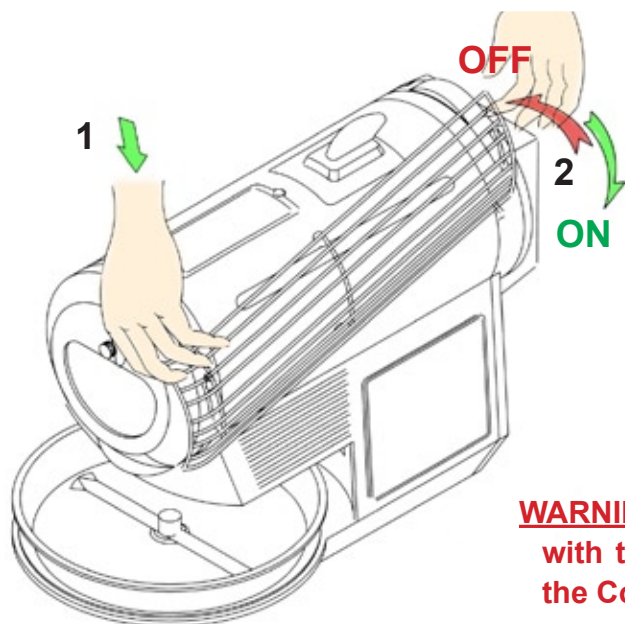
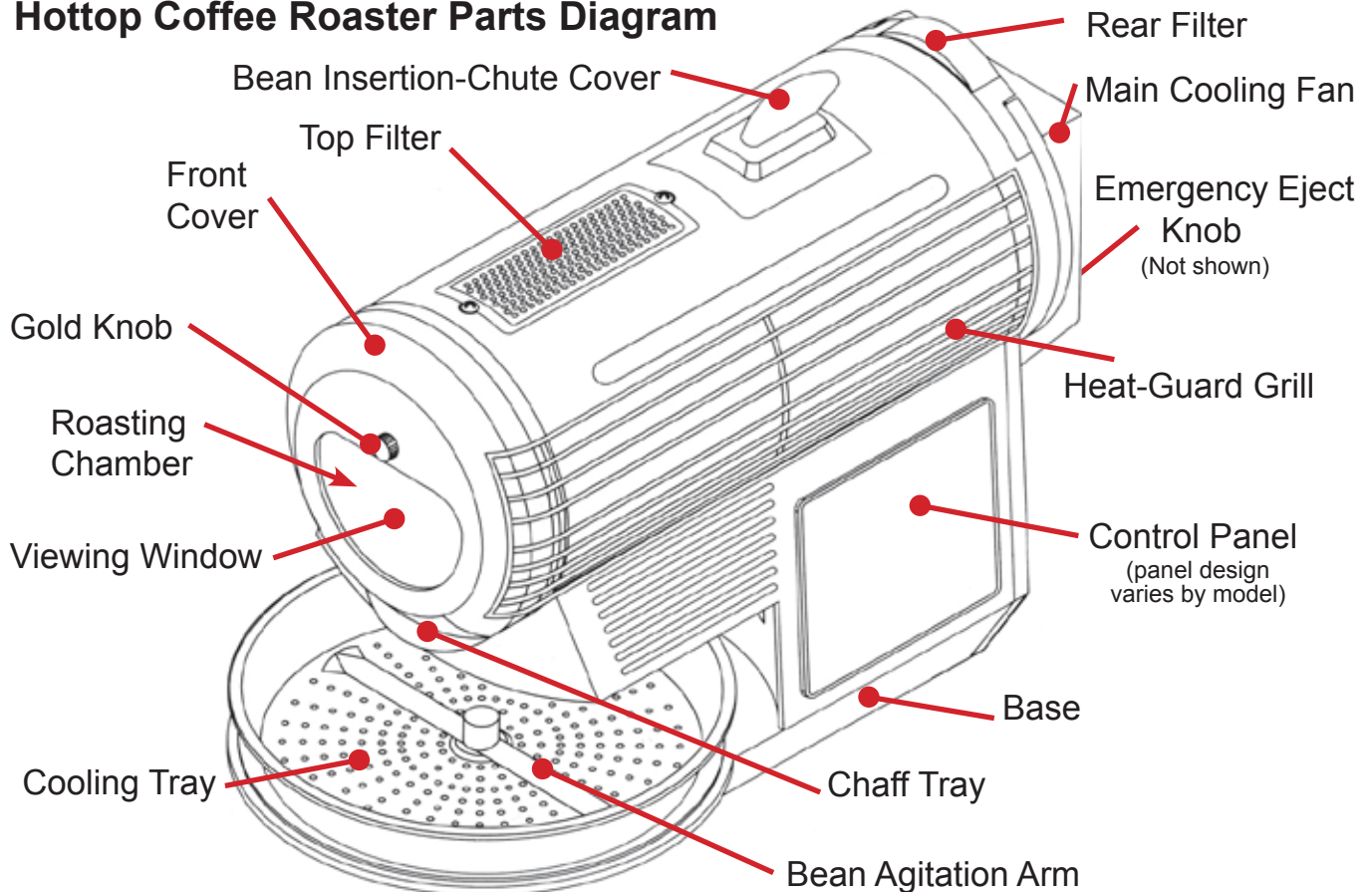

How to Install the Heat-Guard Grills

- 1) Attach front support on mounting hook, holding the guard at an angle as shown.
- 2) Lower rear of guard into position being sure that both front and rear guard-supports are hooked onto Coffee Roaster.

To Remove: Wait until machine has cooled to room temperature. While holding front of guard in place (1), raise rear of guard until support clears the rear mounting hook (2).

WARNING: Always operate the Hottop Coffee Roaster with the heat-guard grills in place. Do not lift or carry the Coffee Roaster by the heat guards.

This diagram represents most of the parts that are designed to be removed by the consumer for basic maintenance with the exception of the Heat-Guard Grills. **1**
 (see bottom of page 6 for heat-guard grill instructions)

WARNING: Do not attempt further disassembly beyond what is shown here, or as required in Section VII.

- 1 - Rear Filter
- 2 - Bean Insertion Chute Cover
- 3 - Cooling Tray
- 4 - Chaff Tray
- 5 - Gold Knob
- 6 - Front Cover
- 7 - Bearing Plate Screws (4)
- 8 - Bearing Plate
- 9 - Roasting Drum
- 10 - Roasting Chamber
- 11 - Alignment Pins (2)
- 12 - Roasting Drum Axle
- 13 - Top Filter

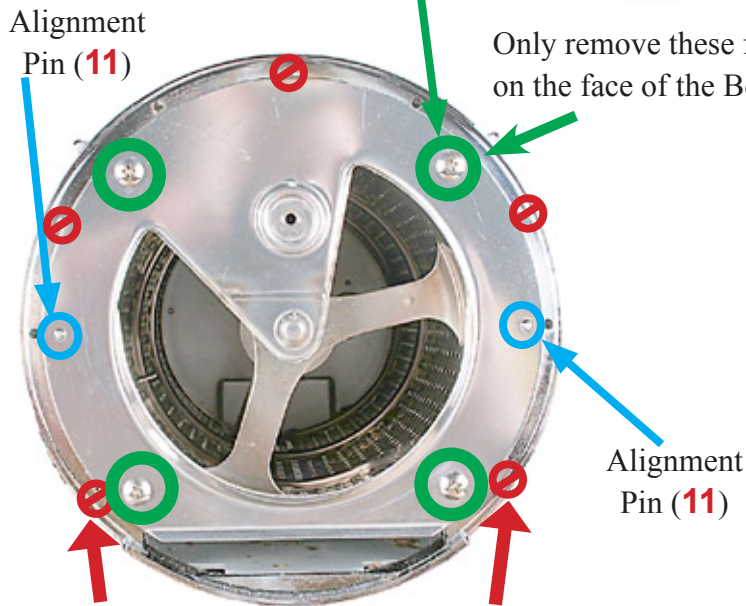
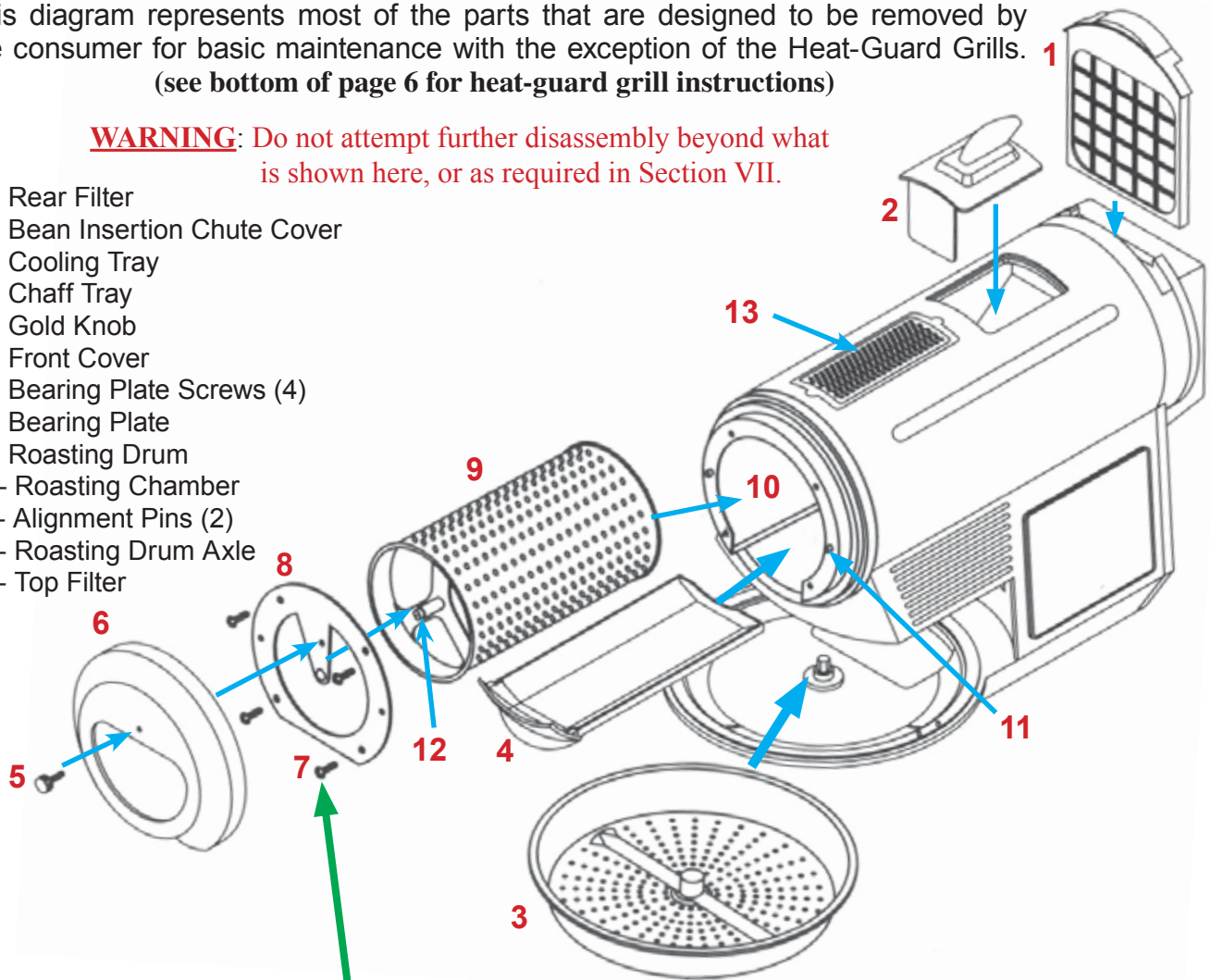

Only remove these four Bearing Plate Screws (7) on the face of the Bearing Plate (8)

Do not remove these five smaller screws!



Use the included funnel to pour the beans into the Hottop Coffee Roaster as shown here.

II - EMERGENCY MANUAL BEAN EJECT SYSTEM



IMPORTANT: The Emergency Eject mechanism is designed to be used in emergency situations only as described below. In normal operation the user should press the “EJECT” button on the control panel to get the beans out of the roasting drum and into the cooling tray.

In certain emergency situations it may become necessary to manually eject the coffee beans from the roasting chamber. Such situations may include:

- The electricity supply to the roaster is interrupted due to a power cord being accidentally unplugged, a blackout, a tripped circuit breaker, or similar failure.
- An electronic failure in the Hottop Coffee Roaster
- A failure of the ejection mechanism to operate normally
- Stoppage of the rotation of the roasting drum.

While failures such as these are rare, for your safety and the safety of the Hottop Coffee Roaster, we have designed a manual Emergency Eject mechanism. Indicated by the red circle in this photo, on the back of the roaster, under the Main Fan, there is a silver-colored knob. If the user pulls this knob outwards, the Eject Door inside the machine will be forced to open and the beans will be ejected from the roaster.

OPERATION OF THE EMERGENCY EJECT MECHANISM

If the machine is otherwise operating normally other than the ejection not taking place when the roast ends or the Eject button is pressed, simply pull the Emergency Eject Knob and hold it out until all the beans leave the Roasting Chamber and drop into the Cooling Tray.

In the rare event of a total failure, interruption of the electrical supply, or stoppage of the drum’s rotation, the user will have to first pull the Emergency Eject knob, and while holding the knob out, tilt the roaster in order to get the beans to leave the roasting chamber. The safest place to hold the roaster in such an instance is to grab the base in front of the cooling tray and alternately lift and then lower the front of the machine.

WARNING: The outer surface of the roaster may be very hot. Oven mitts or heavy, heat-resistant gloves must be worn to protect the user when lifting or moving a hot roaster in such emergency situations. This is the only time a Hottop Coffee Roaster should be handled or moved in this way.

WARNING: Beans may be very hot when ejected from the roasting chamber.



1) Grasp the Emergency Eject Knob



2) Pull Out to Eject Beans

III - Coffee Roasting- A Brief History

It wasn't that long ago that it was common for people to buy raw coffee beans from local stores and then roast these at home for fresh coffee. That was particularly true in rural areas that were removed from the small roasters found in larger city neighborhoods. At that time, roasting coffee was considered a normal part of everyday life and a part of many peoples' cultural heritage. There were many types of small hand-cranked roasting devices available, usually heated with wood, coal, or gas. These were either used in the kitchen, the garden, or on the balcony. People took pride in their ability to produce the type of roast that they liked best, and it was often a sort of cultural ceremony, or art. Each morning in these neighborhoods, the sweet smell of roasting coffee lingered in the streets.

With the advent of instant coffee, developed for the soldiers in WWII, and the post-war boom of the convenience-food industry, the art of coffee roasting was all but lost to the masses. The same corporate brands that produced instant soups and washing detergents erected huge coffee roasting facilities to provide people with a ready-made product. What use to be a fine art became a factory product. Today, most consumers buy pre-ground coffee from these factories, unaware of the culinary tradition that once existed.

Abandoning home coffee roasting has come at a price. While green (raw) coffee will easily keep for over a year with little care, it has been shown that roasted whole coffee beans lose a large part of their flavor after two or three weeks after roasting. Once it has been ground, the coffee stales at an even faster rate, losing its fresh-roasted taste within a matter of minutes. Consequently, most cans and vacuum bricks found on the supermarkets shelves contain a product that has long since lost its precious, volatile flavors. Even when one finds whole beans in a supermarket or specialty shop, one hardly ever knows whether these beans are fresh-roasted, weeks old, or even older- sometimes much older.

Finally, like all convenience products, what you gain in convenience you pay for in lower quality and less flavor. If you think of it in terms of comparing fresh, home-baked bread to pre-sliced, store bought loaves, you begin to get the idea. The coffee available in the stores today may be of uniform quality and style, but it may be very different from what you like best.

For these reasons, the best way to ensure your getting truly fresh coffee, roasted to match your personal preferences, is to return to the great tradition of home coffee roasting. More and more people are discovering this, and home coffee roasting is quickly becoming a culinary delight.

You Are On Your Way Back to the Past

We want to and thank you for your decision to purchase the Hottop Coffee Roaster. We feel that this is the most advanced coffee roaster available for home use, and when used with care will provide you with excellent, fresh-roasted coffee, just like most households use to enjoy, but roasted with scientific accuracy for easily-repeatable results. You are about to find out how good freshly roasted coffee can really taste!

Please take the time to read the instructions in this manual carefully. By doing so, you and your guests will be able to truly enjoy the excellent flavors of specialty coffee, roasted precisely as you will like it. The Hottop Coffee Roaster makes that easier than ever before.

Please keep this manual in a convenient place, so you can reread it when necessary. If you are uncertain about any procedure as detailed in this manual, or are not sure how to get the most out of your Hottop Coffee Roaster, please ask your local dealer or feel free to contact us. We are always ready to help.

IV - Introduction to the Roasting Process

The changes that the coffee bean goes through during the roasting process are amazing. Those small, hard beans, when properly exposed to controlled heat, grow in size and change in color, becoming the source of one of the world's most cherished beverages. The Hottop Coffee Roaster makes it easy to get the best from the coffee.

Getting the best flavor from the coffee is a true culinary art, and just like other similar cooking skills, you have to learn about the process to get the best results. Follow along and you will quickly learn to create the taste you like best. The Hottop Coffee Roaster is designed to allow you to get the best from the coffee, but to do so you need to know what to expect and when to expect it.

Recognizing Roast Level

To get the taste you desire in your coffee means knowing when to stop the roast. As you learn to roast it will become a natural thing to judge roast level, but when starting out it can be a bit intimidating. While you watch the coffee roasting in the Hottop Coffee Roaster you will ask yourself, "Is it done yet? Is it too dark? Should I eject the beans now or wait ten more seconds?" This section of the manual will help you answer those questions.

There are a number of indicators you can use to judge roast level. Even in this computer age, these indicators are the same ones that professional roasters have long used to recognize the level of roast. These indicators include sound, color, temperature and the aromas of the roasting process. If you are new to coffee roasting, the easiest indicator to understand is sound.

Sound

When first beginning to roast coffee, the sounds the beans make are the easiest roast-level indicator to learn. Yes, the beans actually make certain noises during the roasting process and these noises are an accurate indicator of roast level. These sounds are referred to as "cracks" and there are two different cracks that take place at two distinct time periods during the roast. These two different periods, for obvious reasons, are called "first crack" and "second crack." These are universal terms, and if you talk to any commercial roaster and say something like, "I like to roast about ten seconds into second crack," they will understand exactly what you mean.

During both these periods (explained in detail below) the sounds start slowly at first. You will initially notice just an occasional "crack," followed by another a few seconds later. This increases in frequency as sounds become gradually more rapid. After a while, the progression of sounds slows down again, and eventually subsides altogether.

For your first roast, it may be best to seek out a variety of coffee that has very distinct periods of cracking; Central American or South American varieties, such as Colombian or Brazilian coffees are a good choice for your first roasts.

First Crack - This refers to a specific period of time during which you will hear similar sounds. First crack sounds somewhat like breaking wooden pencils: distinct, easily heard, sharp snaps. Because the Hottop Coffee Roaster operates very quietly, it is easy to hear these sounds, even from a number of feet away from the roaster. At this time the beans in the roaster are already light brown, and the grassy smelling steam has changed to a mellow, drier-smelling smoke. You will first hear an occasional snap, then another, then the crackling gradually speeds up, and, after a while, slows down again, then stops.

The actual times at which these periods start and stop again depend a lot on the variety of coffee you are roasting. The coffee you are roasting will affect the differences in sound, volume, and speed of the cracks. In some situations the two periods may partly overlap, making it difficult to tell when first crack ends, and second crack begins.

Second Crack - After first crack ends there is usually a period of about one or two minutes before second crack begins. By that time, the beans are a delicious-looking, dark shade of brown. Second crack can be a little more difficult to hear as these sounds are lower in volume, but once you learn to distinguish the sound it is unmistakable. It is a more muffled, subtle sound than first crack. Second crack sounds like

breaking toothpicks. Generally, once second crack really gets going the individual cracks occur with much greater frequency than the sounds during first crack.

The beginning of second crack is an indicator that the coffee is nearly done and you should be ready to end the roast very soon. When second crack begins to diminish, most coffees are near the end of their preferred-flavor profile, and when second crack ceases the beans are on the edge of being ruined and are approaching the ignition point.

Timing of the Cracks

As you become more accustomed to roasting coffee on your Hottop Coffee Roaster you will be able to use time as a general indicator, but time should not be depended upon for accuracy. There are many factors that can affect the various times at which to expect events during the roast including:

- Beans chosen (different varieties have various roasting characteristics)
- Actual weight of beans (can vary depending on your scale's accuracy)
- Volume of beans (250 grams of one variety can take up more space than the same weight of another variety)
- Size of Beans - some beans are small (peaberry) and some quite a bit larger (Colombian Supremo)
- Ambient air temperature and humidity
- Moisture level of the beans
- The voltage in your home (it can vary as much as 12-15 volts from place to place)

On page 19, "Getting the Most From Your KN-8828B-2K," you will find a graph which represents a roast. Reminding you again that your times will most likely vary, the graph will give you some idea as to when certain events occur whether roasting with the KN-8828B-2K or the KN-8828P-2K.

Bean Color and Temperature as a Roast Indicator

Coffee beans go through series of a subtle, and sometimes not-so-subtle color changes from their original color. The beans will turn to green early in the cycle, and later to beige, then through a whole range of browns- first dull then shiny as they darken, and progressing to a brown so dark that it can look black. Because of the consistency of these color changes, color is an excellent indication of the roast progress.

Temperature is also an indicator of the state of the roast. Although the temperature sensor of the Hottop roaster does not display the actual temperature of the beans, the display is still useful as it will help you predict changes taking place in the beans. Temperature is particularly useful when roasting decaffeinated coffee because it can be more difficult to see color changes and there will not be as many crack sounds as "regular" coffee.

Note that temperatures on the "Coffee Roasting Color Samples" on page 13 are added to give you a general idea as to what is happening in the roaster. Your temperatures may vary depending on the factors listed above.

V - Basic Roasting Instructions and Your First Roast

That was a lot of information to remember, but follow along and it will all become quite clear during your first roast. Believe it or not, using the Hottop Coffee Roaster is actually quite simple and safe when the procedures and safety guidelines in this manual are followed.

WARNING: Never leave the roaster unattended during a roast!

This chapter will familiarize you with the roasting process and the way the Hottop Coffee Roaster actually works. Before starting to roast your first batch of beans, be sure you have completely read and understand the safety precautions and instructions presented in this manual.

Remember that the only purpose of this first roast is to practice, so don't be concerned if the coffee doesn't come out as you might expect. If you follow the safety precautions and the operating procedures, roasting coffee with the Hottop Coffee Roaster is fun, easy, and safe.

For your first batch select a variety that is easy to roast. Most any of the varieties from Central or South America will do fine. Guatemalan, Colombian, Brazilian, Bolivian, or Costa Rican are all good choices. These coffees have very loud cracks that are easy to recognize, and they are relatively inexpensive, so if anything goes wrong, you don't have to feel too bad about discarding the beans.

CAUTION: Before beginning your first roast, please read and understand the section of this manual dealing specifically with your roaster:

Page 14 for the KN-8828B-2K - Page 22 for the KN-8828P-2K

Basic Operation of the Hottop Coffee Roasters

The Hottop's default programmed roasting process consists of three distinct stages which are controlled by the internal microprocessor, and unless you decide to interrupt or modify the process, all function automatically.

WARNING: Never leave the roaster unattended during a roast!

1. WARM UP - during this time the roaster pre-heats much like you would do with your oven before baking, but in this case it is entirely automatic, controlled by the Hottop Coffee Roaster's programming.

2. ROASTING - When the machine signals to add beans the roasting process begins. The roasting cycle will normally take from about ten to twenty minutes, but can be as long as twenty-five minutes or as short as you decide depending on how YOU want to roast the beans!

3. COOLING - After roasting, for best taste, it is important to cool the roasted coffee as quickly as possible, this is called the cooling cycle. The Hottop Coffee Roaster features an external cooling tray, and it cools the beans down to approximately room temperature in less than five minutes.

After pouring the beans into the Hottop Coffee Roaster it is important to always remain near the machine and pay attention at all times. Refer to the "Coffee Roasting Color Samples" on page 13 and watch the beans through the window in the front of the Hottop Coffee Roaster. You will see the gradual changes in color taking place.

Make a mental note of how much volume the beans take up when first poured in. You will notice a definite increase in volume as the beans expand during the roast. The various aromas of the smoke change throughout the roast as well. Initially, there is a little humid smoke that has a pleasant grassy scent. As the roasting progresses, this turns into a more dense smoke that smells like hay, and later somewhat like making pancakes or baking bread. Smoke is a normal by-product of coffee roasting, so don't worry. Smoke does not mean that there is anything wrong with your machine. Smoke production will increase as the temperature of the coffee beans rises. Darker roasts create more smoke than lighter roasts.

Sound is the most reliable indicator when you are roasting your first batches. When the beans are a cinnamon-brown color and the temperature is about 385 F. you will hear the first sounds of "first crack." It is almost impossible to miss these loud and fairly sharp snaps. Apart from being an obvious sign of where the beans are in the roasting process, the sound of first crack also tells you that you should start monitoring the process even more closely. Although little has happened up to this point, the roasting will proceed very fast from this point forward, and the beans will change a lot in the next few minutes.

As first crack ends, there is usually a short pause of around one or two minutes. Now is time to be *very* alert, and listen for second crack which is a much softer sound, and can be a bit more difficult to hear. This may also be around the time when you will hear the beeping of the Hottop Coffee Roaster that signals it is near the end of its roasting cycle or is signaling a temperature alert.

If the machine doesn't eject the beans automatically, push the "Eject" button about the time that second crack becomes active (*about* 400-410 F.) or even before this time. The Hottop Coffee Roaster then proceeds with the cooling cycle. When the cooling cycle ends the machine beeps repeatedly to indicate that it has finished the entire roasting and cooling process, and then shuts itself off.

VI - Coffee Roasting Color Samples



1 - These are "green," raw coffee beans before adding them to the roaster. When looking at green beans you can get an idea as to their quality by the consistency of size and color of the beans. If at all, there should be very few beans that look dark, mottled, or have other defects like insect damage. Some varieties have more defects than others.



2 - These beans are at around 285 F. degrees (display temperature of 335 F.). There are in the midst of the drying phase as indicated by their green color. The aroma of the smoke from the machine will be humid and the smell will remind you of grass clippings.



3 - The beans have just passed through the drying phase and are turning tan. The drying phase is concluding and the "real" roasting begins. This color indicates that the beans are at around 305 F. degrees (display temperature of around 320 F. or more)



4 - The beans have gone from tan to a light brown. They are at about 325 F. degrees (display temperature of 350 F.). Compare this to the picture of the green coffee and you can see that the beans have come a long way since being added to the roaster.



5 - At around 365 F. degrees (display temperature of 368 F.) the display temperature is very close to the actual temperature of the beans. Things are happening now at a faster rate, and even closer attention needs to be paid because we are getting close to having a successful roast.

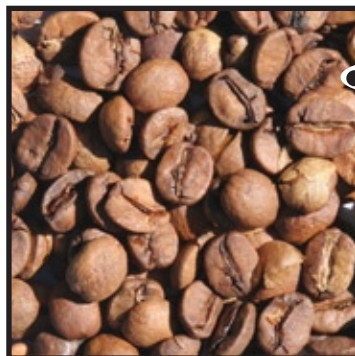

6 - First crack has begun. The beans are at about 400 F. degrees (display temperature of about 385 F.). There are some coffees that can be quite delicious at this roast level or a little darker. This is more true for beans used for drip and perk than press or espresso.



7 - These beans are in active second crack at about 430 F. (with a display temperature of around 400 F.). At this point you need to be ready to press the EJECT button because as little as five or ten seconds more or less can affect the taste of the coffee.



VII - Model KN-8828B-2K Color LCD Display Auto Coffee Roaster with Manual Control

The KN-8828B-2K allows easy roasting of the coffee for new users, yet supplies complete manual control for those who become advanced in their roasting knowledge and are looking for a specific taste or roast level. Roast Profiles can be saved for later use as well. Physically, it is the same as our other model. The only difference is the user interface of the control panel.

In the Auto mode the user will find that with just three pushes of the START button the coffee roasting process will begin. In the manual mode, all parameters of the roasting process can be controlled by the user. These modes and how to operate them are fully described in this chapter.

UNDERSTANDING THE LCD DISPLAY

The first thing that you will notice is the colorful LCD display panel. This is the interface between the user and the roaster. Let's begin by understanding what is displayed here. Detailed instructions on how to use the various functions of the KN-8828B-2K will be found on pages 15 through 17.

NOTE: The display components vary depending on which mode is in use. Only functions that are currently available will be illuminated.

When first plugging the KN-8828B-2K roaster into an outlet the user is given the choice of whether to enter "Auto" or "Manual" mode.

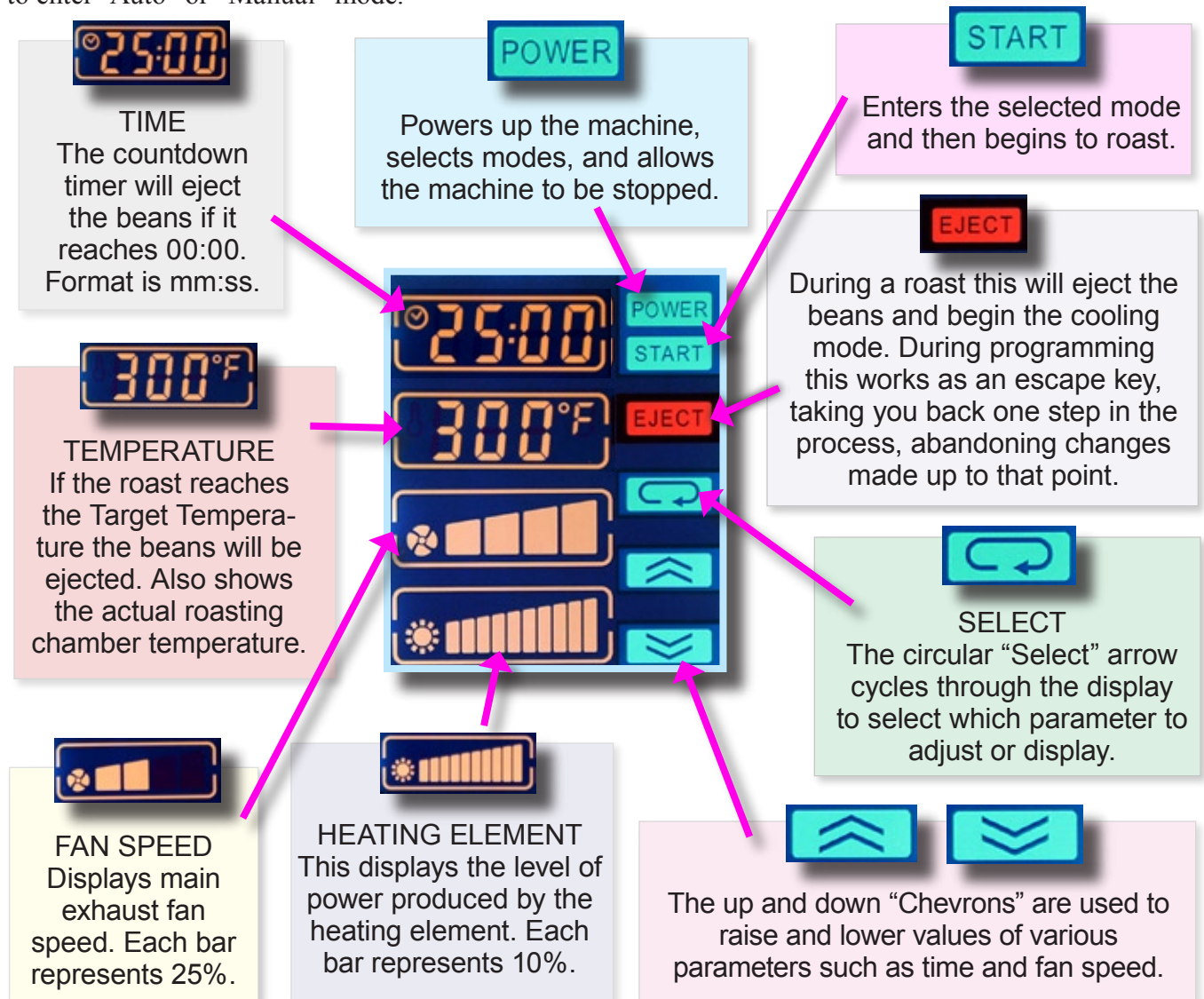

CONTROL FUNCTIONS

To the right of the display are five buttons that control KN-8828B-2K (buttons do not illuminate).

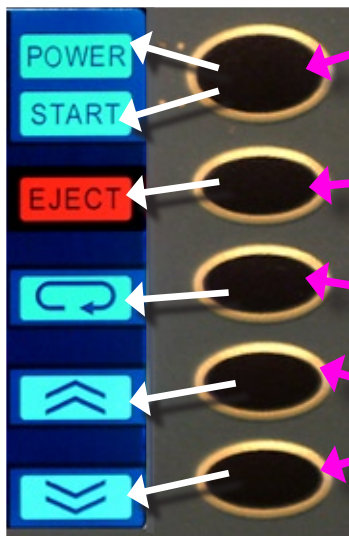

POWER - START - The largest button at the top of the display controls both “POWER” and “START.” Only one of these two choices will be illuminated in the LCD display at any given time so the button is used for this dual function.

EJECT - This is always available during a roast. Use it to immediately stop the roasting process and send the beans into the cooling tray.

SELECT - The circular arrow is used to cycle through the various parameters that can be adjusted. Adjustable parameters are Target Time, Target Temperature, Fan Speed and Heating Element Power.

CHEVRON ARROWS - The arrows are used to change each of the four parameters. For example, select “Fan Speed” using the SELECT Arrow then use the CHEVRON arrows to change the fan speed higher or lower. It works the same for the other three parameters.

MESSAGES

At various times a message will appear in the display to alert you:

CHAF

CHAF - The chaff tray needs to be emptied before continuing.

Stor

Stor - If you choose you may store into non-volatile memory the roast which just took place

Auto

AUTO - The pre-programmed, factory default, automatic roasting mode. 18:00 and 420 F. are the default values for AUTO mode.

COOL

COOL - The roaster is cooling itself down before it can proceed.

Ad 1

Ad - These are roasting profile memory locations where you can store profiles for future use. The three areas are named Ad1, Ad2, and Ad3.

P H

PH - The roaster is preheating in preparation to roast coffee.

FACTORY PROGRAMMED SAFETY

There are three separate safety points programmed into the KN-8828B-2K:

1) If the KN-8828B-2K displays a temperature of 356F (180 C) within the first 8:30 of roasting time, the unit will alert you with warning beeps. If you do not press a button (other than EJECT) within 20 seconds, the beans will be automatically ejected. Pressing a button continues the roast as programmed.

2) When the KN-8828B-2K displays a temperature of 395 F (or 202 C), the roaster will again alert you with warning beeps. If you do not press a button (other than EJECT) within 20 seconds, the beans will be automatically ejected. Pressing a button continues the roast as programmed.

3) When the KN-8828B-2K displays a temperature of 428 F (220 C), the beans will be immediately ejected. There is no override for this safety function.

ROAST PARAMETER CHANGES

During the roasting process you can change any of these four parameters: Target Time, Target Temperature, Fan Speed, and Heating Element Power. These changes are temporarily memorized by the roaster. This “set” of adjustments and changes is called a “Profile.” When the roast is over and the cooling cycle has completed, the display will show “Stor.” At this time you may choose to save the Profile so that this same roast can be repeated again in the future.

RANGE OF CONTROL ADJUSTMENTS



Target Time
10:00 to 25:00



Target Temperature
167 to 428 F.



Main Fan Speed

Five speeds. Each of the four bars represent 25%. When no bars are showing the fan is off.



Heating Element Power

Eleven selectable heating levels. Each bar represents 10% of the heating element's power. When no bars are selected the heating element is off.

TARGET TIME and REMAINING TIME

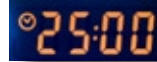

During the actual roasting process the time display will countdown the remaining time in the roast. If the Select arrow is used to choose the time display it becomes encircled (shown to the left). The remaining time can now be modified by adding or subtracting time using the Chevron up and down arrows. At any point in the roast, if the time display reaches 00:00 the KN-8828B-2K will automatically eject the beans. When the display is not encircled (above right) the display will still show the amount of time remaining in the current roast. The Target Time can be changed at any time during the roast. The total roast time (time elapsed + time remaining) cannot exceed 25:00. When the Target Time is selected, the Up Chevron arrow will not be available if 25:00 would be exceeded by the addition of more time.

TARGET TEMPERATURE and CURRENT TEMPERATURE



During the roast, the temperature display can show two different parameters. If the Select arrow is used to choose the temperature display it becomes encircled (shown to the left). This is the Target Temperature which, if reached, will automatically eject the beans. When the display is not encircled (above right) it is the current temperature in the roasting chamber. The Target Temperature can be changed at any time during the roast up to the maximum of 428 F. If the Target Temperature is lowered to the point that it equals the current temperature the beans will be ejected.

SELECTING TEMPERATURE MEASUREMENT UNITS

The KN-8828B-2K Coffee Roaster can be set to display temperatures in Fahrenheit or Celsius. To change the displayed units follow these steps. This only needs to be done once unless you desire to change the standard in the future. **NOTE:** Throughout the following step-by-step sections, **black and yellow** highlighted words refer to the button selections on the control panel of the same name:

1



With the KN-8828B-2K unplugged, press and hold the **SELECT** button (3rd button from the top).

2

While holding the **SELECT** button in, plug the power cord into an appropriate outlet. Hold the button for about three additional seconds. The machine will give a quick double-beep. You can now release the **SELECT** button.

3



The display will show the temperature standard. Change it by using the **CHEVRON** arrow keys. The choices are either "C" for Celsius or "F" for Fahrenheit.



4



When the preferred temperature standard is displayed, press **EJECT**.



Model KN-8828B-2K AUTO Mode

WARNING: Read and understand this owner's manual and *all* the safety precautions *before* following these step-by-step instructions!

WARNING: Never leave the roaster unattended during a roast!

The KN-8828B-2K gives the user the option to easily and quickly roast using an automatic mode. The "Auto" mode supplies a roasting curve that can begin with as few as three presses of a single button. It can be modified to run for a programmed amount of time or a programmed temperature and will automatically eject the beans when either parameter is reached. It also allows time to be changed at any time during the roast or for the target temperature to be modified. The roast can be stopped at any time the user desires. If this is your first time roasting coffee we highly recommend starting with the AUTO function.

1  Plug the machine into an appropriate outlet and **POWER** becomes illuminated. Press the button next to **POWER** to begin.

2  "AUTO" is the default display.

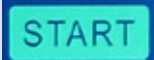
3  Select Auto Mode by pressing the button next to **START**

4  To begin roasting with the default parameters of "AUTO" mode, press **START** once more and the roasting process begins.

5  "PH" flashing in the Target Time display area indicates that the roaster is in "Preheat" mode. When the roaster signals you with a series of beeps (at 167 F.) it is time to pour in the green coffee beans.

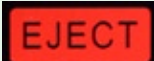
6  At any time, if you wish to end the roast, simply press the **EJECT** button and the machine will eject the beans and begin the cooling mode.

7 While the roast is in progress, there are three safety points. The first may occur at 356 F (180 C). The other two will occur at 395 F (202 C) and 428 F (220 C) if those temperatures are achieved before the roast ends (see "**FACTORY PROGRAMMED SAFETY**" on page 14 for details).

MODIFYING ROAST PARAMETERS

Either before the roast begins or after the Pre-Heat (PH) cycle ends, various roasting parameters can be changed. Before beginning the roast, only Target Time and Target Temperature are available to be modified. During the Roast you can change Fan Speed and Heating Element Power as well.

1  Use the **SELECT** Arrow key to highlight the parameter you wish to modify.

2  Here you see the box around the time parameter indicating that it is selected and displaying Target Time which continuously shows the remaining roast time before the beans are ejected. Target Time is now ready to be modified.

3  To change the Target Time use the **CHEVRON** arrows. Individual presses of the arrows increase or decrease the time by ten seconds. Holding down an arrow speeds up the changes.

(continued)



4 Target Temperature, Target Time, Fan Speed, and Heating Element Power can all be adjusted at any time during the roast. Use the **SELECT** arrow to choose a parameter, then use the **CHEVRON** arrows to change that parameter.

CAUTION: When adding time or increasing the roasting temperature, care must be taken not to burn the beans.

STORING (Saving) A ROAST PROFILE

When the roast has completed and the cooling cycle is done, if you like the way the roast turned out and wish to repeat this roast at any time in the future, you may save it. The KN-8828B-2K offers three, non-volatile memory areas in which to store Profiles. Each area holds one Profile which can be easily recalled for use in the future.

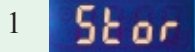

1 Select an **Ad** area (Ad1, Ad2, or Ad3) using the Up or Down Chevron Arrows and then press **Start** and the roast parameters and changes will be stored. The Profile is saved in non-volatile memory and will be available to you until you save a different profile in that memory location.



KN-8828B-2K Roasting with a Stored Profile

WARNING: Read and understand this owner's manual and *all* the safety precautions *before* following these step-by-step instructions!

WARNING: Never leave the roaster unattended during a roast!

After you have saved a roast using the "STOR" function you can recall that roast and use it again.

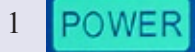

1 Plug the machine into an appropriate outlet and the **POWER** illuminates. Press the button next to **POWER** to begin.



2 "AUTO" is the default display. To select a stored profile use the **CHEVRON** arrows...

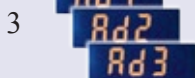

3 ...and navigate through the choices to select the desired stored Profile. There are a total of four choices- AUTO, and the three memory areas where the Profiles are stored. These are named: Ad1, Ad2 & Ad3.

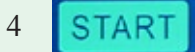

4 When the stored program you wish to use is displayed, press the **START** button to begin the roasting process.

5 The remainder of the roasting process is the same as previously described above in the "Auto Mode" instructions. If the selected Profile is modified during the roast, the new Profile can be saved in the same or a different "Ad" area when the roast concludes.

Getting the Most From Your KN-8828B-2K

The KN-8828B-2K allows the user to adjust the power of the heating element as well as the speed of the fan throughout the roast. This section is designed to show you how to use this control to more precisely tailor the roast. The information contained in this section will also interest the users of the KN-8828P-2K.

Over the years, roasting theories concerning profiles have changed. A lot of that has been driven by the amount of control the user has over the appliance they are using. Up to this point there have been few home roasting devices that allow the user to control the roaster precisely. The KN-8828B-2K changes that.

During the roasting process the coffee undergoes a number of dramatic changes, and if the user pays close attention, these changes will act as indicators and allow you to more-precisely control the roast. The beans go through a number of color changes (see page 13), and even changes in their size. Chemically, certain elements in the bean are changed, and at one point near the end of the roast the beans are actually *creating heat energy*! As you become more familiar with those changes you will be able to predict what you need to do. As with all electrical heating devices, there is a bit of lag time between making a change in the heating level and the actual change in the environmental temperature, and the knowledge presented here will help you predict when to make changes using the control panel of the KN-8828B-2K.

Refer to the following graph and read along, Highlighted red numbers in text “(1)” refer to the black highlighted numbers in this graph:

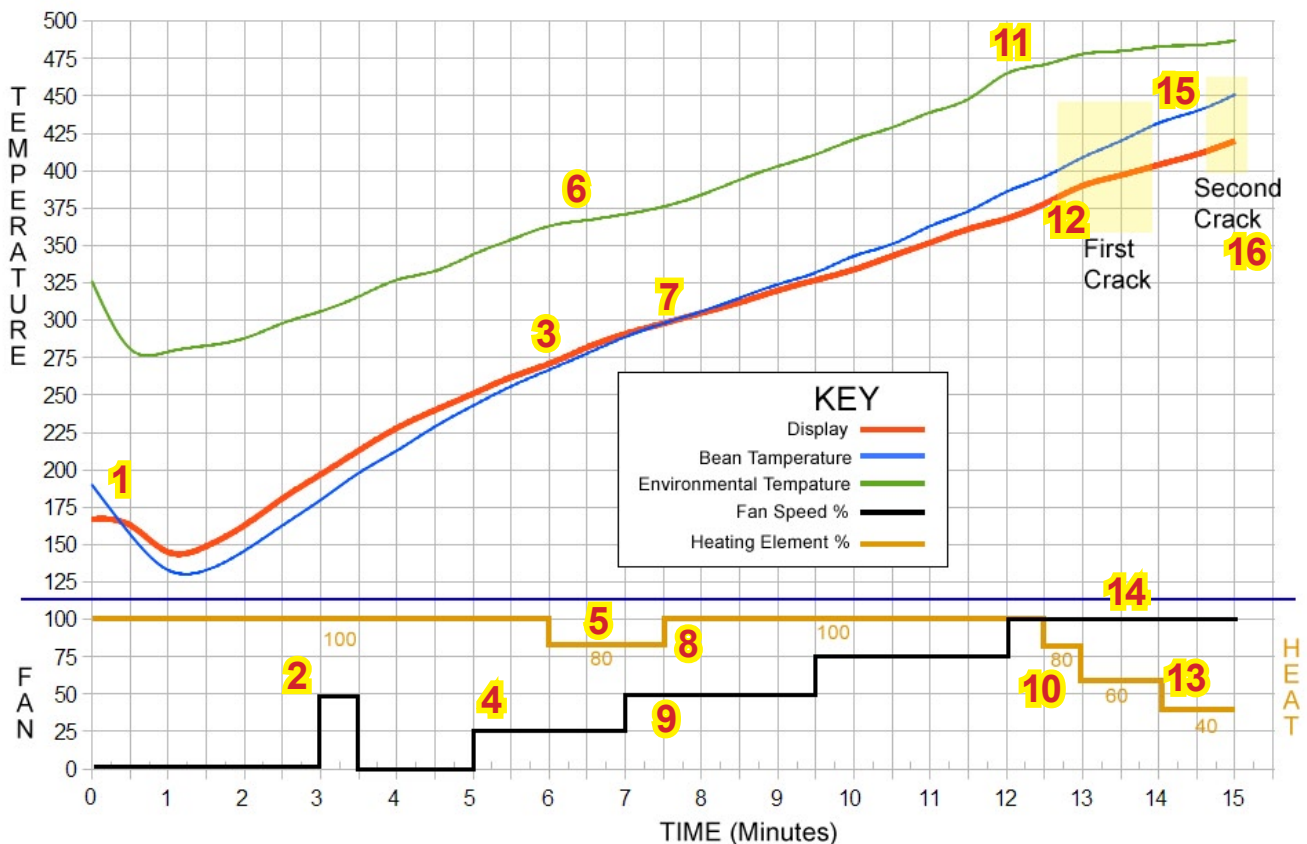

This **RED** line data was taken from the LED display on the KN-8828B-2K. That is the temperature which you will refer to when roasting. The other temperatures are from an after-market digital thermometer added to our KN-8828B-2K test unit for the purpose of gathering the information for this graph. The **BLUE** line is bean temperature from a probe in the bean mass itself, and the **GREEN** line is a thermo-sensor in the hot air, in the drum, near the top of the roasting chamber. “Time” started when the beans were added to the roaster. Note that all times and temperatures are for general reference only. Your results will vary depending on various factors such as bean moisture level, air temperature, voltage supplied to the roaster, amount of beans being roasted, condition of main filter, etc.

The roast used for the graph was done by programming the KN-8828B-2K for maximum time (25:00) and maximum temperature (428 F.). Using these parameters, start the roast as instructed on page 17. Many users have experimented with the temperature at which they add the beans to the roaster. In this roast the beans were dropped in at an the “Beep” signal at a temperature of approximately 167 F. on the display (1), as the red line indicates. You might try waiting until the display shows 200 to 225 F. and see how that works for you. The amount of beans used also will affect the roast. To begin with we recommend using 250 grams. You may experiment later with 225 to 235 grams to see how this affects the roast, and most importantly, the flavor. Smaller amounts of beans will speed the roast.

**Remember that coffee is a food product.
The most important factor is
HOW THE COFFEE TASTES TO YOU!!**

After you add the beans to the roaster they begin to absorb heat energy, transferred to them by convection (exposure to the hot air), conduction (through the hot metal of the drum), and to a lesser degree radiation (radiant energy from the heating element).

When the roaster hits about 200F., turn the fan to 25% or 50% (2) for thirty seconds to one minute. This will help clear moisture out of the roaster that comes from the beans. When the display temperature reaches around 280 F. (3) the beans are about to enter the important drying phase. Watch through the observation window on the front of the roaster and you will see the beans begin to change to a green color as shown on page 13. Moisture in the beans is being removed and you might begin to notice a pleasant, grassy smell somewhat reminiscent of a freshly mown lawn.

At this time it is important to allow the beans to lose their moisture throughout their structure. This insures that the entire bean roasts evenly as the temperature rises later in the roast. Rushing through the drying phase may roast the outer areas of the beans sufficiently, and the beans can look fine, but the inner portions on the bean can be left at a lesser roast level causing unpleasant tastes in the cup.

To control the drying phase, at around 259F. set the fan to 25% (4) and at around 280 F., turn the heating element to about 70 or 80% (5). Once again, the fan will help clear humidity from the roaster which is coming from the moisture inside the beans. The goal here is slow the increase in temperature in the roaster until it reaches around 300F. which marks the end of this phase. This allows the temperature of the inside of the beans to “catch up” with the temperature of the outer surface.

Note that when the heating element was turned down (5), it took some time for the temperature in the roasting chamber to react to that event (6). As mentioned earlier in this section, this is normal for an electrical heating element. Learning how to predict this is part of the learning process and being aware of this will help you get the most out of your KN-8828B-2K when roasting manually.

Keep in mind that while attempting to control the temperature it is better to allow it to rise slowly than to drop. If the temperature in the beans is allowed to drop during the roast it can lead to undesirable results. Keeping the display temperature rising slowly during the drying phase will assure that the beans are safe. As you get more experienced in use of the controls of the KN-8828B-2K you will be able to more precisely control the temperature.

All this time you should keep an eye on the beans. They will go from light green to an amazing bright green color. This marks the height of the drying phase. The bright green will begin to fade and they will begin to turn tan in color. Around the time that the green color is beginning to fade it indicates that the beans themselves are in the vicinity of 300 F. (7). This is the time to turn the heating element up to 100% again (8). Shortly after that the smoke will increase and it is time to turn up the fan (9). Over the next four minutes or so the temperature of the beans will continue to rise and the tan color begins to darken towards cinnamon and brown. Watch carefully. At an indicated display temperature of around 360 F., the display temperature will be showing the bean temperature as their temperature plots cross. This is a time when things are happening quickly.

At around 370-375 F. an adjustment should be made. To keep the beans from going through the end of the roast too quickly, it is time to turn the heating element down (10). Notice that even though the graph’s green line (environmental temperature), begins to level off (11), the bean temperature is still rising (12)!

Just as you are entering first crack there is a chemical reaction going on in the beans called the Maillard Reaction. Chemical changes in the beans are actually creating heat- the beans are becoming exothermic. The sounds of first crack begins with a sound reminiscent of breaking small wooden sticks. It begins with a few clicks and then increases in frequency. As first crack becomes more active, the heating element should have already been turned down to around 50% (13). Depending on how things are going you may need to turn the fan up as well (14).

Another change you will notice is that the beans are expanding. That is where the sounds of first crack come from. You will observe that the level of the beans in the roasting chamber has risen against the glass. They expand so much that they emit that distinct cracking sound.

The roast is nearing completion, and you are just minutes away from ejecting the beans. First Crack is about to end at about an indicated 400 F. If you have done well up to this point, from the end of first crack to the beginning of second crack you should have a pause of about two minutes (15). The exact length of time does not have to be precise, but if you get about 1:30 to 2:00 minutes lull time between those two periods you are doing a pretty good job.

As you can see, this roast progressed a little too quickly and the heating element should have been turned down a little earlier and down to about 30% by the 13:30 time mark. This example is offered because it is important for you to realize that you shouldn't hesitate to make adjustments other than those specifically described in this section. The goal of this section is only to give you a better understanding of what is happening so you can learn to control the process. Much like trying to write an article on how to fry an egg, it is easy to tell someone to raise the pan to control the temperature of the pan as well as what to watch for, but difficult to tell them exactly how high to raise the pan on the burner— knowing that takes experience.

Notice again that even though you have turned the heating element's power down to half, the temperature continues to rise. Listening carefully and you will begin to hear the first few clicks of second crack. These sound like breaking toothpicks (16). It will start just like first crack, with a few stray clicks, and then turn to a rapid series of those same sounds. If the number of these clicks per minute decreases be wary! This is the time when coffee is becoming so dark that it can lose a lot of its flavor. When the beans look oily or greasy, five seconds is a long time in the life of a roasting coffee bean. Even though the graph line of the display temperature is now beginning to flatten, the bean temperature continues to rise as second crack progresses.

This is the time you need to decide when to hit the eject button to end the roast. But when? There is no one answer. When to end the roast depends on the coffee you are roasting and how it will be brewed, and most importantly, your preferred taste. For Colombian coffee brewed as drip, I would recommend trying a lighter roast than you may be accustomed to. Maybe hit eject just before second crack begins, or maybe even predict second and eject the beans a minute before second crack starts. For an espresso blend, try ejecting about ten seconds after second crack becomes active.

Over time, if you experiment with various roast levels you will be surprised at how the taste changes depending on the various changes you make during the roast. Experiment! Don't be afraid to try some lighter roasted coffee. Try to vary the drying time. Try shorter or longer time periods between first and second. Each of these changes will change the taste of the coffee- sometimes for the better, sometimes not.

Be aware that as a general rule, the lighter the roast, the more the coffee benefits from a post-roast rest period before first use. Some coffees actually benefit from a ten day rest, but about two to four days is usually sufficient for most coffee.

Roasting coffee is part science and part art. We hope this section gave you a better understanding so that , over time, you can use this scientific knowledge to become a coffee roasting artist.



VIII - Model KN-8828P-2K Programmable Roaster with LCD Display

The KN-8828P-2K is a programmable roaster with many advanced features giving the user a lot of control over the roasting profile. It allows an easy, automatic mode that takes little user input to start. In addition to the Automatic mode, the KN-8828P-2K also gives the user the ability to create their own roasting profiles, thus modifying the roasting process to suit their tastes. Internally, the KN-8828P-2K model is much the same as our other models, and can be maintained in the same way. The difference is that there is a more sophisticated main circuit board inside the roaster's base to control the roasting process and the LCD panel on the outside that give the user far more information and control than our other models. This section of the manual fully explains the KN-8828P-2K and how to make best use of all its features.

UNDERSTANDING THE LCD DISPLAY

The first thing that you will notice is the LCD display panel. This is the interface between the user and the roaster. Let's begin by understanding what is displayed here. Detailed instructions on how to use the different modes, and how to program the KN-8828P-2K will be found in subsequent sections.

NOTE: The display components vary depending on which mode is in use.

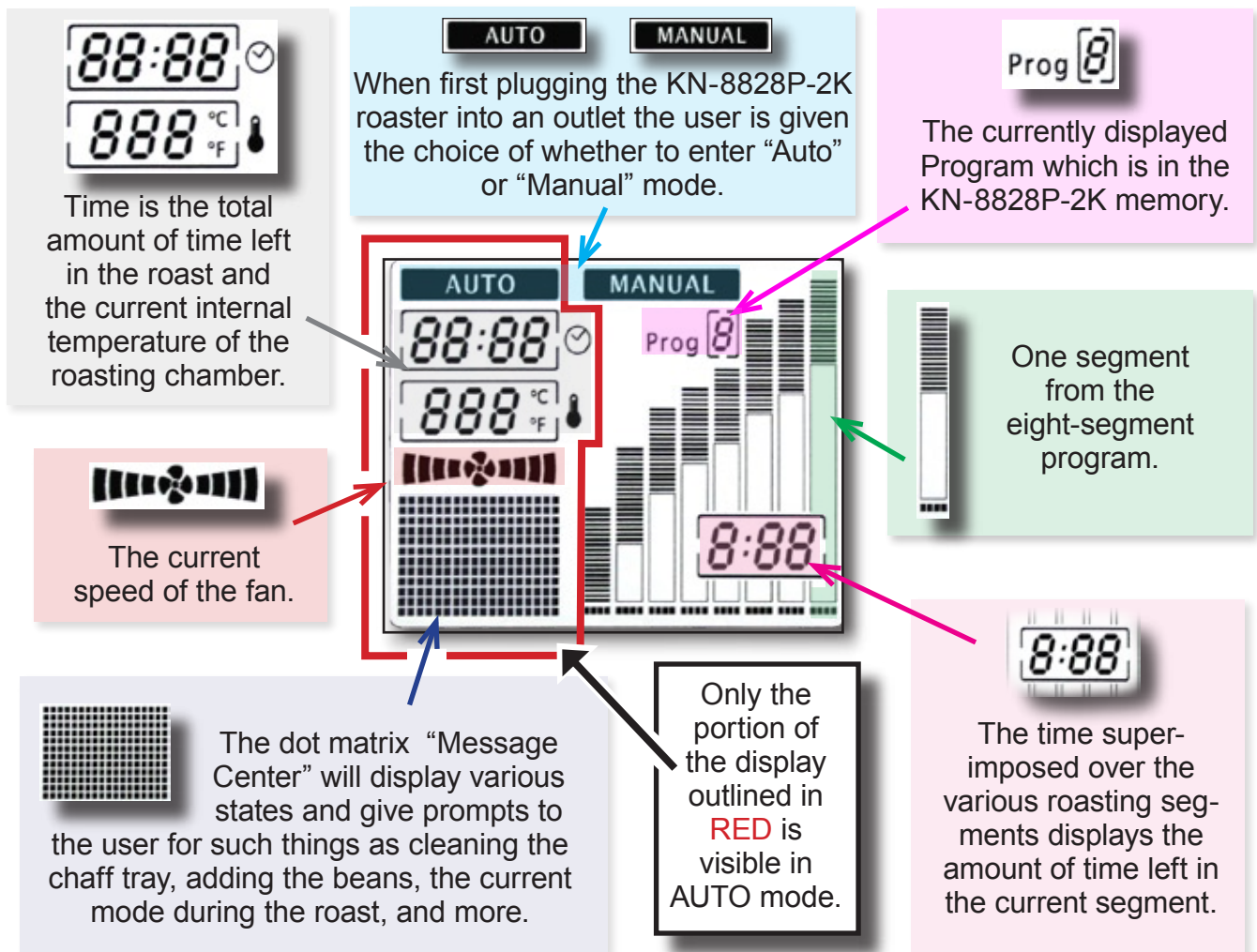

ACTIVE BUTTONS ILLUMINATED

You will notice that in any given state of operation some of the buttons on the Control Panel are not illuminated. The advanced programming of the KN-8828P-2K assists the user by illuminating only those buttons which are currently active. For example, when you have added six “Pluses” during the roast you have reached the maximum number available and at that point the “+” button is no longer illuminated.

FACTORY PROGRAMMED SAFETY

There are three separate safety points programmed into the KN-8828P-2K:

- 1) If the KN-8828P-2K displays a temperature of 374 F. (190 C), the unit will alert you with warning beeps. If you do not press the “Enter” button within 30 seconds, the beans will be automatically ejected. Pressing the “Enter” button continues the roast as programmed.
- 2) When the KN-8828P-2K displays a temperature of 395 F. (202 C), the roaster will again alert you with warning beeps. If you do not press the “Enter” button within 30 seconds, the beans will be automatically ejected. Pressing the “Enter” button continues the roast as programmed.
- 3) When the KN-8828P-2K displays a temperature of 428 F. (220 C), the beans will be immediately ejected. There is no override for this safety function.

CHAFF TRAY SAFETY SWITCH

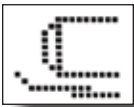

The Chaff tray has a safety switch that will not allow the operation of the roaster unless the chaff tray has been emptied after a roast. Even if the machine is unplugged the tray still needs to be removed for emptying before operation. An animation of the chaff tray appears in the message Center to remind you.

SELECTING OPERATING MODE

AUTO

MANUAL

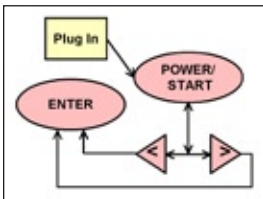



The KN-8828P-2K operates in either “Auto” mode or “Manual” mode. Auto mode operates based on a pre-programmed profile. Manual Mode operates using one of ten Programs that are used to control all aspects of operation.

As shown in this flow chart, when you first power up the KN-8828P-2K by plugging it in and pressing the “POWER/START” button you have the choice of which mode to use. The default is “AUTO.” Use either the “<” or the “>” button to choose the mode you desire. The Display will show the selected mode. Press “ENTER” to begin using the displayed mode.

SELECTING TEMPERATURE MEASUREMENT UNITS

The KN-8828P-2K Coffee Roaster can be set to display temperatures in Fahrenheit or Celsius. To change the displayed units follow these steps. This only needs to be done once unless you desire to change the standard in the future. **NOTE:** Throughout the following step-by-step sections, **black and yellow** highlighted words refer to the buttons on the control panel of the same name:

- 1  Press and hold the **SET/SAVE** button
- 2 While holding the **SET/SAVE** button in, plug the power cord into an appropriate outlet. Hold the button for a few additional seconds. The screen will change to purple. You can now release **SET/SAVE**.
- 3  The display will show the temperature standard. Change it by using the “+” or “-” button. The choices are either “C” for Celsius or “F” for Fahrenheit.
- 4  When the preferred temperature standard is displayed, press **BACK/EJECT**.



Hottop Coffee Roaster KN-8828P-2K AUTO Mode

WARNING: Read and understand this owner's manual and *all* the safety precautions *before* following these step-by-step instructions!

WARNING: Never leave the roaster unattended during a roast!

The KN-8828P-2K gives the user the option to roast using an automatic mode that operates much like the earlier versions of our roaster. The “Auto” mode supplies a roasting curve that can be set to run for a programmed amount of time and will automatically eject the beans at the end of that time. It also allows additional time to be added at the end of the roast as well as allowing the roast to be stopped at any time the user desires. If this is your first time roasting coffee we highly recommend starting with Program “0” by pressing:





or use the programming function below.

1  Plug the machine into an appropriate outlet and the “Power” button illuminates. Press the **POWER** button to begin.

2  “AUTO” is the default display.

3  Since you are going to roast using this mode, select it by pressing **ENTER**.

4  The time display will appear. Here you will enter the amount of roasting time you wish to use. The “18:” signifying minutes will be flashing.

5  Pressing either the **+** or the **-** button allows you to change the programmed number of minutes in a range from 15 to 21.

6  Press **>** to change the display to seconds. The “00” portion is now flashing. You can program a number of seconds from :00 to :59.

7  Use the **+** and **-** keys to change the number of seconds. If necessary, press **<** to go back to minutes. This can be repeated until the desired amount of time is on the display. As you proceed through this process notice that only the keys which are enabled in any given mode or at any given time are illuminated.

8  Once the desired amount of time has been programmed, press **ENTER**. The screen goes from the yellow-green programming background to the white background showing that the KN-8828P-2K is ready to begin roasting.

9  Notice that the **POWER-START** button is now illuminated green showing that the roaster is ready to start. Pressing it begins the AUTO Roasting mode.

(continued)

10

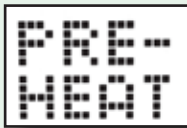

In the display's Message Center you will now see "Preheat." The roaster is coming up to temperature. The amount of time this process takes varies.

11

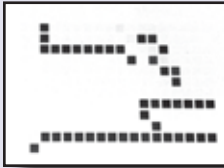

When it is time to add the beans, the machine will beep and the Message Center will show the "Add Beans" animation. Add the beans and the roast will progress automatically.

12



After the "Add Beans" animation ends the roaster goes into the "Roasting" mode and progresses through its roast. The time display counts down from the amount of time you programmed towards 0:00. The temperature display shows the real-time temperature in the roasting chamber.



While the roast is in progress, if at any time the temperature display reaches 374 F., a safety feature will warn the user by beeping a warning. If the user does not press **ENTER** within 30 seconds the beans will be automatically ejected. It happens again at 395 F.

13



With 40 seconds left in the programmed time, the roaster will beep and the display will show "Plus Time." If you choose to add more time, press the **+** button. This will add 30 seconds to the roasting time. After an additional 30 seconds the machine will beep again, and more plus time can be added. Six "Pluses" can be added in this way, which extends the roasting time an additional three minutes over and above the original programmed time. **CAUTION:** When adding Plus Time care must be taken not to burn the beans.

14

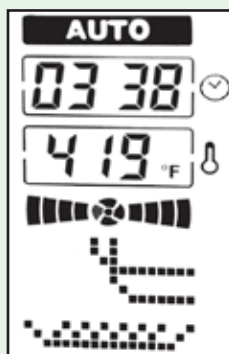

At the end of programmed time, or after Plus Time has expired, or when the user has pressed the **EJECT** button, the beans are automatically dumped into the cooling tray and a four minute cool down begins, with the animation shown here displayed in the message center on the screen.

15



When the Cool Down mode is over, the machine will signal you with beeping and the LED display turns from white to a yellow-green tint, and the Chaff tray animation will display, reminding you to remove and empty the chaff tray before beginning the next roast.

Hottop Coffee Roaster KN-8828P-2K MANUAL Mode Roasting with Programs



WARNING: Read and understand the owner's manual and *all* the safety precautions, *before* using the manual Mode of the KN-8828P-2K!

“Manual Mode” allows the user to control the roaster to create a roasting profile that they prefer. This mode offers a lot of flexibility and offers a powerful, yet easy-to-use interface. The following pages document the various ways to create, modify, and use the Manual Programs.

The LCD display gives the user a lot of information and is the interface for the manual programming mode. Because of that it is very important to understand what it is saying to you. Refer to page 17 for the explanation on those elements of the interface not explained here:

PROGRAM

A Program contains the information on how the Manual roast will proceed. Up to ten Programs can be saved for later use. These are stored in non-volatile memory and are saved even when the machine is unplugged for extended periods of time. The number of the current program is shown above the Segment display as seen here.

Program 0 - This program is factory installed and cannot be changed or deleted.



Program 1-9 - These nine programs are for your use. When the machine arrives, these programs are “blank”- they contain no information. Programs can also be named.



SEGMENTS

Each “Program” is comprised of eight “Segments” which are implemented automatically, in order, during the roast. Each Segment will have three major components:

SEGMENT TIME

The amount of time that a segment is active during a Programmed roast can be from “0:00” to “3:00.” Although there are eight segments, and each can be three minutes in length, the greatest amount of time for any given Program is 22:00. The KN-8828P-2K will not allow you to save a Program that is greater than 22:00 in total length (not including the Warm-up time which is automatically added to every roast).

During the roast, time is displayed in three areas on the display:

The remaining amount of the total roast time is displayed in the upper-left area along with the temperature.

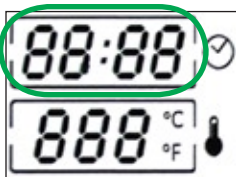

The amount of time remaining in the current roast Segment is displayed numerically, superimposed over the Segment Display



A graphical representation of the time remaining for the current Segment is shown at the bottom of each Segment in the form of four small squares. Each square represents 1/4 of the time for that specific Segment. Glancing across the bottom of the Segments is another way for the user to see how far the roast has progressed.

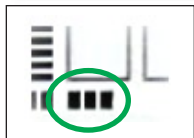

SEGMENT TEMPERATURE

The temperature range for each segment which is available for programming varies, from lowest in the early segments to highest in later segments. This is reflected in the “stair step” appearance of the temperature bars in the LCD display. During the roast, each segment dynamically displays its progress of the temperature:

The upper portion of each Segment display where the black bars are located represents the range of programmed temperature this way:

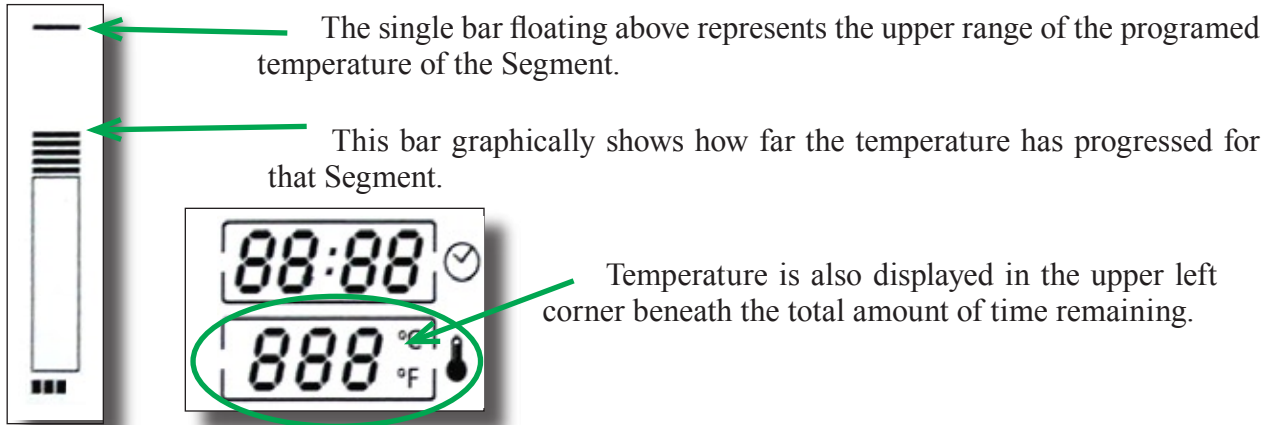

SEGMENT FAN SPEED

This can be Off, and speeds of 1, 2, 3, and 4, with 4 being the fastest. If the fan is active the fan blades of the icon in the center will “spin” and the speed will be indicated as shown here:



PROGRAM NAME



With ten different Programs it can be hard to remember which is which. Each Program can have a name comprised of three alpha-numeric characters. The factory set Program 0 is called “STD.” You can name the remaining Programs as you wish.

SCREEN COLOR

Depending on what mode or function you have accessed, the LCD screen will change color to alert you of a change in mode. Some examples are:.



Save a copied Program



Temperature Measurement System change



Delete a Program



A pause or alert



Roasting or ready to roast

SELECTING A KN-8828P-2K PROGRAM

Before you can begin roasting with a Program you must select which Program to use. For your first roast we suggest trying “Program 0” which is the factory default Program. This will help you understand how Programs operate before attempting to create your own roasting profiles. Follow these directions to select a Program:

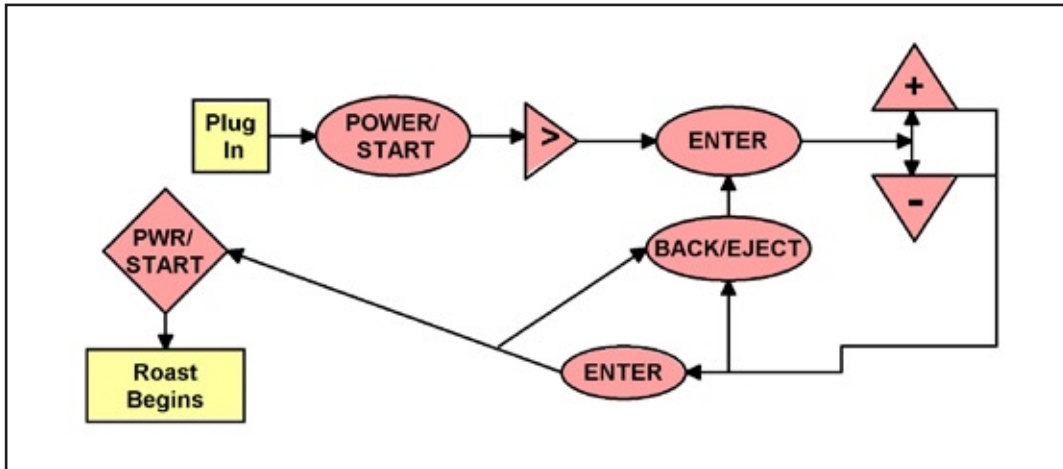

Plug the machine into an appropriate outlet and the “POWER/START” button will become illuminated. Press “POWER/START” and you will notice in the display that “AUTO” is the default.

Press “>” to change the displayed mode from “AUTO” to “MANUAL” and then Press “ENTER” to select that mode.

The complete display will appear on the LCD display. The numeral in the “PROG” area is flashing “0” and the name of the Program, “STD,” is displayed in the Message Center.





STD, Program 0, is the default, factory-installed Program which cannot be modified or deleted. Choose the Program you wish to use by using “+” and “-” buttons. You will see the currently selected Program Number in the numeric display. The selected Program’s alpha-numeric designation will also be displayed in the Message Center.

When the Program you wish to use is displayed, press “Enter.” The display changes color and the KN-8828P-2K is now ready to begin the roast cycle. At any time during this process of choosing a Program, you may press “BACK/EJECT” to go back through the various main areas of the process. For example, if after you press “ENTER” to choose a Program you decide to use a different program, just press “BACK/EJECT” to get back to the screen which allows the selection of a Program and use the above process to change the selection.



ROASTING WITH A PROGRAM - KN-8828P-2K

WARNING: Never leave the roaster unattended during a roast!

- 1  Select a Program with which to roast as described on the previous page. If you have not yet created any additional Programs use “Program 0” which is the default Program when entering Program mode. After Selecting a program, begin the roasting process by pressing the green **POWER-START** button.

- 2  In the display’s Message Center you will now see “Preheat.” The thermometer icon next to the digital temperature display is flashing. The roaster is warming, coming up to temperature. The amount of time it takes to pre-heat varies depending on the such factors as the ambient air temperature and whether it has recently been used.

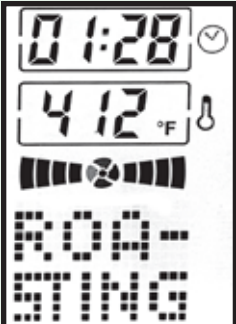
- 3  When it is time to add the beans, the machine will beep and the Message Center will display the “Add Beans” animation and the roast begins. Pour the beans into the roaster and the roast will begin.

- 4  After the “Add Beans” animation ends the Message Center displays “Roasting.” The roaster can progress through the Program on its own. The main Time Display counts down from the total amount of time in the selected Program. The Temperature display shows the current temperature in the roasting chamber.
-  While the roast is in progress, if at any time the temperature display reaches 374 F., a safety feature will warn the user by beeping a warning. If the user does not press **ENTER** within 30 seconds the beans will be automatically ejected. It happens again at 395 F.

- 5  The eight Segments of the Program Display show a lot of important information. In the temperature area of the Segment shown here you can see that some of the bars are displayed and some are not.
- The single bar above the Segment indicates the programmed temperature goal for this segment
- The space between the single bar and the lower portion of the Segment’s display graphically represents how close the actual temperature is to reaching the goal of the programmed temperature.
- You can tell that this segment is currently active because, as seen here, the first three time-squares are now displayed, and the third is blinking showing that in this instance that the third-quarter of this segment’s programmed time is active.

NOTE: It is possible for the roaster to not reach the programmed temperature goal for any particular segment. That does not necessarily indicate that there is a problem. (continued)

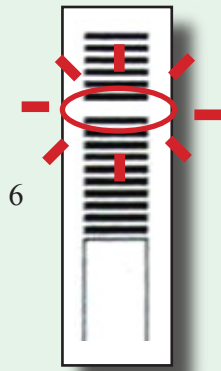

It is possible to adjust the temperature of an active segment during the roast. Use the **+** and **-** buttons to adjust the temperature. Either button can be held down to move through the adjustment range more quickly. If you reach either extreme in the temperature range for that segment, that particular button will no longer be available. For example, if you are pressing the **+** button to get a segment as hot as possible and you reach the highest possible temperature for that segment, the **+** button will no longer be illuminated signifying that no higher temperature is currently available. Although there is no digital display of the adjusted temperature, the bar representing the selected temperature will be flashing even if occurs somewhere inside the range of temperature bars which have already displayed as seen here.

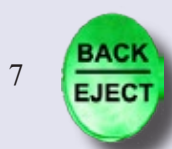

At any time during the roasting process, if you decide to end the roast, press the Green-illuminated **BACK-EJECT** button and the machine will go into cool down mode. This stops the roasting process, dumps the beans into the cooling tray, energizes the agitation motor that stirs the beans, starts the cooling fan under the cooling tray, and runs the Main Fan on high to cool the roasting chamber.

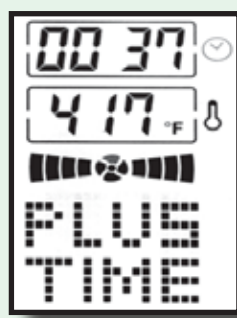

With 40 seconds left in the Program, the roaster will beep and the Message Center will display “Plus Time.” If you choose to add more time, press the **+** button. This will add 30 seconds to the roasting time. At the end of that added 30 seconds the machine will beep again, and another “Plus Time” can be added. Six “Pluses” can be added which extends the roasting time an additional three minutes over and above the original programmed time. **CAUTION:** When adding time in this manner great care must be taken not to burn the beans.

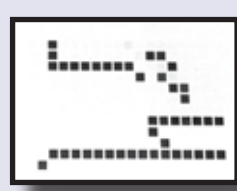

At the end of total programmed time, Plus Time, or when the user has pressed the **EJECT** button, the beans are automatically dumped into the cooling tray and a four minute cool down begins, with the animation shown here displayed in the message center on the screen.

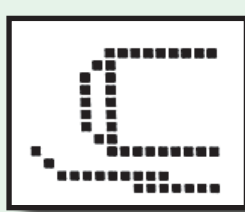

When the Cool Down mode is over, the machine will signal you with beeping and the display illumination turns from the LED white to a yellow-green, and the Chaff tray animation will display, reminding you to remove and empty the chaff tray before beginning the next roast.

COPYING AN EXISTING PROGRAM - KN-8828P-2K

If you would like to create a new Program it can be easier and a bit quicker to begin with one that is already created. Here is how to copy a Program and paste it into another Program slot:

1 Select the Program you wish to duplicate (see Page 24 for instructions on “Selecting a Program”)

2  Press **SET/SAVE**

3  Press **SET/SAVE** again. The LCD screen is now illuminated in green and the Program has been copied to memory, and is now ready to be Saved (pasted) .

4  If necessary, use the **+** and **-** keys to navigate to the desired Program area. Programs 1-9 can only be copied when there are empty Program areas. After copying, only empty Program areas will be accessible using **+** and **-** for pasting Programs 1-9. Copying Program 0 will automatically select the first empty Program area. If there are no empty Program areas, Program “1” will be automatically selected after Program 0 has been copied. **This happens even if Program 1 is not empty**, so copy Program 0 with care. Be sure to check the current Program number before pasting.

5  Press **ENTER** and the Program is pasted.

CAUTION: When the STD Program is pasted it is written to the first empty Program area. If all Programs are already used it defaults to Prog 1. This procedure may overwrite an existing Program without warning if the user does not use care. Be sure that there is an empty Program before proceeding!

It is always a good idea to record all successful programs so that they can be re-entered later if lost. Duplicate and use the handy charts we have included on page 48 and 49 for that purpose.

DELETING A PROGRAM - KN-8828P-2K

There are times when you may wish to remove a saved Program completely- possibly to make room for duplicating a Program from areas 1 through 9. The following process will delete any Program in areas 1 through 9 (Program 0 cannot be deleted). To delete a Program:

1 Select the Program you wish to delete
(see Page 24 for instructions on “Selecting a Program”)

2  When the Program you wish to delete is displayed in the “Prog” area and it’s name is showing in the Message Center, press and hold both “**<**” AND “**>**” for about two seconds. When this has been successfully done the screen will turn red.

3  Press “**ENTER**” and the Program is permanently deleted.
CAUTION: Deleted programs cannot be retrieved, so use this function carefully!

CAUTION: When a Program is deleted, its area in memory will be empty and ready for entering a new Program, but the deleted program cannot be retrieved.

It is a good idea to record all successful programs so that they can be re-entered later if lost. Duplicate and use the handy charts we have included on page 48 and 49 for that purpose.

Understanding Programs and Segments - KN-8828P-2K

Now that you have a basic understanding of how a Program roasts coffee, you can begin to create and modify your own Programs. This section will help you understand the parameters of programming the KN-8828P-2K.

This chart visually shows the eight Program Segments and the temperature range of each available for programming. You will notice that the chart resembles a staircase, with the steps rising in temperature as you progress along the roasting process. Here are some hints, tips, features, and facts that will help you create successful Programs:

- Generally speaking, coffee should not be allowed to cool off during the roast. Chemical changes are taking place in the coffee beans, and if they lose too much heat during the roast the reaction can be harmed and the taste of the coffee will be negatively affected. It is fine to maintain a temperature level, but dropping the beans' temperature should generally be avoided.

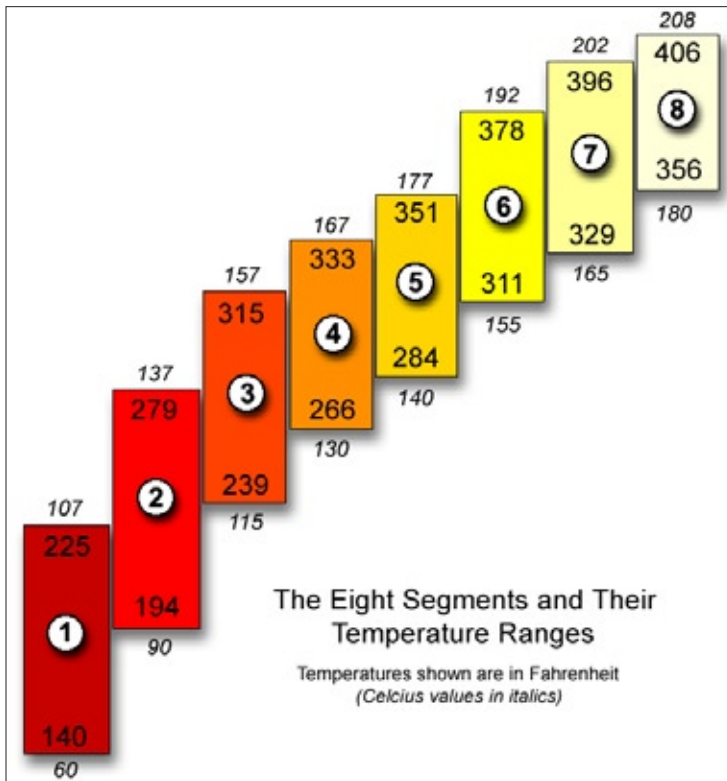

- A program is made up of up to eight Segments. Each Segment will have a setting for time, temperature, and fan speed.

- The smallest amount of time in a Program is 10:00, and the greatest is 22:00. A Program must have at least 4 programmed Segments (Example: 3 segments at 3:00 each, plus one additional Segment of at least 1:00).

- You do not need to use all eight segments when roasting. A Segment can be eliminated from the Program by entering "0:01" for its time.

- If the user desires a temperature to be held for more than three minutes (each Segment's maximum programmed time) consecutive segments can be programmed for the same temperature. For example, Segments 3 and 4 can both be programmed for "300" and 3 minutes each, totaling 6 minutes, to hold the temperature at that level once it is reached.

- In any given Segment, or portion of a Segment, once the programmed temperature is achieved, the KN-8828P-2K will cycle

the heating element to hold that temperature until the time for that Segment expires.

- If the temperature for a Segment is not achieved during its programmed time, the program will still move on to the next segment. During this time the heating element will stay on until the temperature programmed for the current Segment is reached. This can be used for a more rapid temperature rise.
- It is not important for the roaster to reach a programmed temperature in a Segment. Setting a high, unattainable temperature in a Segment is a way to force the heating element to stay on during that time period.
- Because of the amount of time it takes for the KN-8828P-2K to increase the temperature in the roasting chamber, drastic changes should be avoided unless a Program is created that gives sufficient time for the rise in temperature before time runs out for the Program. When creating Programs, if you take into account that the KN-8828P-2K can change temperature at a rate of between 0.2 F/sec - 0.5 F/sec, you can create a more accurate and controlled Program.

A Sample KN-8828P-2K Program and It's Roast

For a better understanding on how a Program affects the roasting process we present this graph of an actual sample roast and the program that created it.

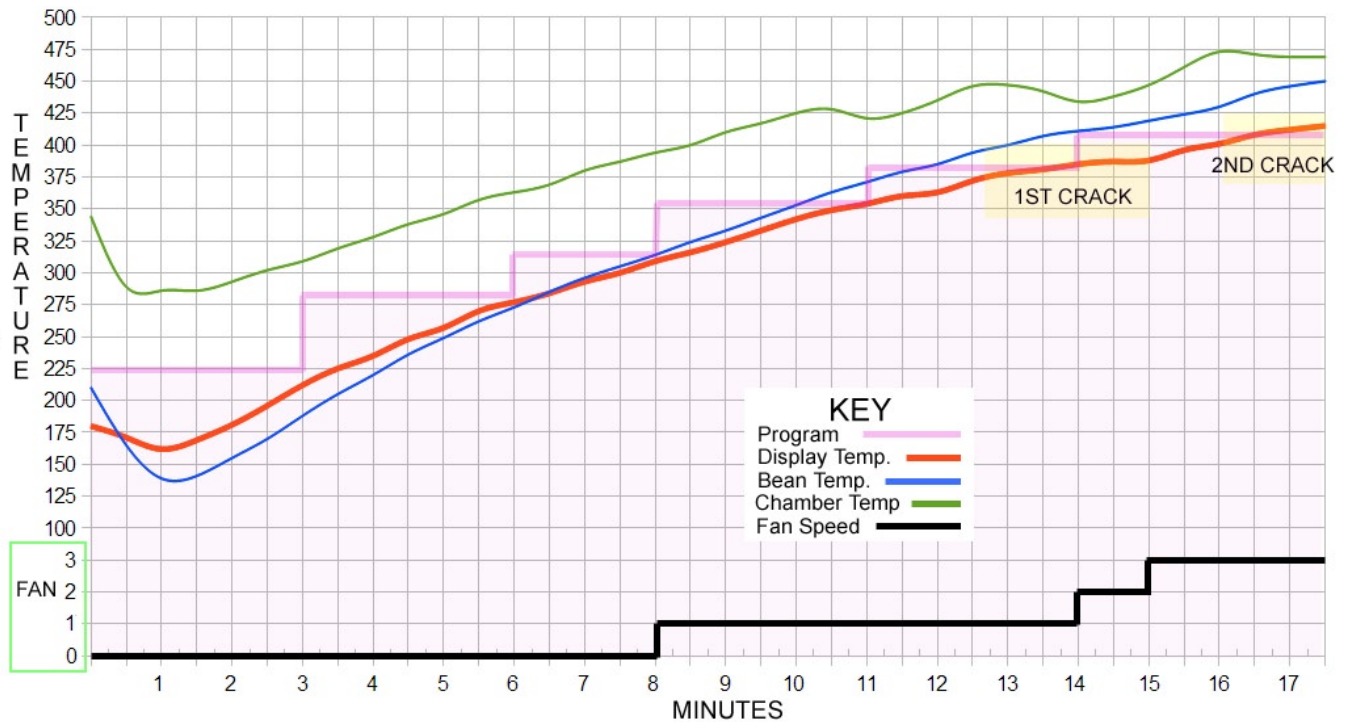

SEGMENT	TIME	TEMP	FAN
1	3:00	225	0
2	3:00	279	0
3	1:59	315	0
4	:01	333	1
5	3:00	351	1
6	2:00	378	1
7	1:00	378	2
8	3:00	406	3

Beans Used - - - - - Brazil Sierra Negra
 Amount of Beans - - - - - 250 grams

The **red line** represents the temperature readout as shown on the LCD display during the roast.

The **blue line** indicates the programmed time.

The **green line** is the temperature near the top of the roasting chamber (this is called the environmental temperature, or the “ET”).

The **lavender area** indicates the program I created for this roast.

The **black line** is the fan speed.

The total program time was seventeen minutes with one “Plus” added for a total roast time of about 17:30. This roast was automatically ejected at the end of that time, about 90 seconds from the time the first click of second crack was heard.

One interesting point to note is the way segment 6 and 7 are programmed to the same maximum temperature. This was done to add more user-control over the end of the roast. Because segment 7 can be programmed to 396, This gives me the ability to increase or decrease the temperature during this critical point in the roast.

Finally, notice the “wave” in the ET near the end. This is where the heating element was being turned off then on by the control circuits when the programmed temperature was reached during those segments.

Modifying a KN-8828P-2K Program

Any Program (except Program 0) can be modified. Modification can be anything from changing a single entry (such as “Temperature” for “Segment 3”) to creating an entirely new program by modifying every parameter. The programming process described below is illustrated in this flow chart:

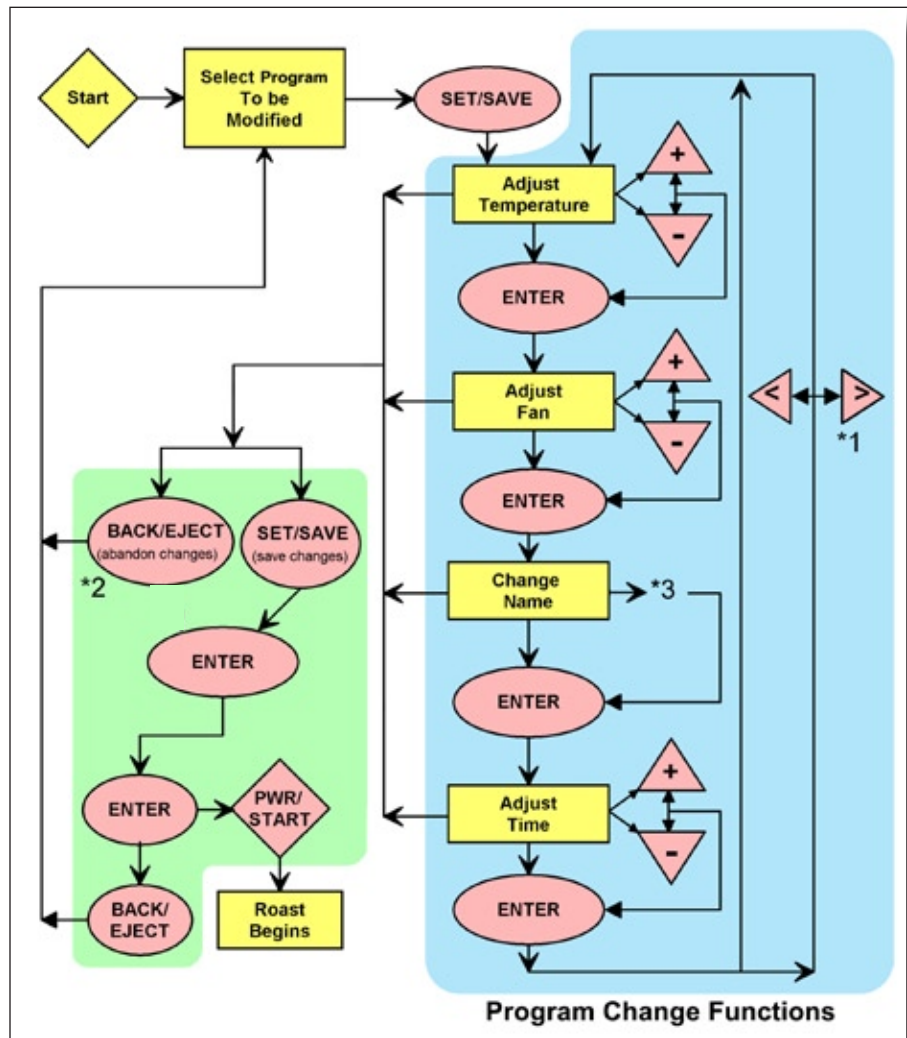

Enter the “Program” mode and select the Program to be modified as described earlier. Press “SET/SAVE.” The “SET/SAVE” button turns green signifying that you are in the setting mode for changing parameters for the selected Program. You have entered the area of the flow chart which is indicated inside the blue rectangle.

TEMPERATURE

When you enter the setting mode, the KN-8828P-2K defaults to Segment 1 and “Temperature.” You will notice that all the bars of Segment 1 are displayed and a temperature bar signifying the current selected temperature for Segment 1 is blinking and the digital temperature display is blinking. Using the “+” and “-” buttons you can now adjust the temperature for Segment 1 as desired.

For any given adjustment, the “+” or the “-” buttons may or may not be illuminated. If a button is not illuminated it signifies that you have reached the limit for that portion of the range for that specific function in that Segment. For example, if you have selected the highest programmed temperature for Segment 1, then the “+” button will no longer be illuminated. When you have completed adjusting the Temperature for Segment 1, move on to the next adjustment in Profile 1 by pressing “ENTER.”

FAN

Now the Fan icon is blinking and you can adjust fan speed for Segment 1 using the “+” and “-” buttons. Adjust the fan speed as you desire, and then press “Enter” to move on.

PROGRAM NAME

This next adjust allows you to change the Program's name (indicated as *3 in the flow chart on page 34). This can be a three-character, alpha-numeric name you choose from these available characters:

Capital letters from A to Z Numerals from 0 to 9 “_” to signify a blank

To aid in understanding the Naming Procedure, refer to this flow chart:

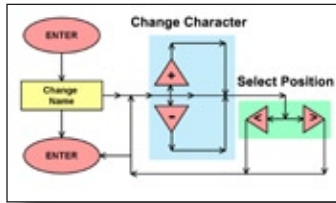

The first character in the Program's Name is now blinking. Use the “+” and “-” to scroll forwards and backwards through the available list of characters. The list wraps and can be scanned faster by holding the button down. When the desired character is displayed press “<” or “>” to move to the next position in the Program's Name. Repeat this process, and when all three characters meet with your approval press “ENTER” to move on. Be aware that this changes the name for the entire Program and not just one Segment.

TIME

Segment Time is the next step in the adjustment process. This can be from “0:00” to “3:00.” No segment can be more than three minutes, and the total of all the segments cannot be more than 22:00. When the amount of time for this segment is as you desire, press “ENTER” and you will return back to the top of the process at “Temperature.”

At this point you need to select the next Segment for modification. Press “>” or “<” to move to the next adjacent segment (*1 on the flow chart). The Segment that is selected will display all its temperature bars and you can go through all the settings as described above. Repeat this process for all Segments. You may change the current, active Segment at any time during this Program-modifying process.

ABANDON CHANGES

Press “BACK/EJECT” at any time during this Program modification process. This action will discard all changes (*2 on the flow chart). You will be brought back to the Program Selection screen.

SAVE CHANGES

When your changes are completed and you wish to save this Program and all the changes you have made to it, Press “SET/SAVE” and the LCD screen will turn green and the Message Center displays “SAVE.” Press “ENTER” and the changes will be saved.

To begin roasting with this profile, press “ENTER” once again, and then “POWER/START.”

CHANGING ONE PARAMETER - “Quick Programming”

An alternative to the process described above makes use of the flexible programming methods of the KN-8828P-2K. Instead of modifying all the parameters for each Segment, one Segment at a time, you may wish to modify only one of the parameters for all Segments. For example, if you want to change just the Temperature settings of some or all of the Segments and wish to leave the other parameters alone, follow these directions:

Just as with the previous method, enter the “Program” mode and select the Program to be modified. Press “SET/SAVE.” The “SET/SAVE” button turns green signifying that you are in the setting mode to change parameters for the selected Program. You have entered the area of the Program Modification flow chart (page 34) that is indicated inside the blue rectangle.

The setting mode defaults to Segment 1 and “Temperature.” You will notice that the all the bars of Segment 1 are displayed and a temperature bar signifying the current selected temperature for Segment 1 is blinking and the digital temperature display is blinking. Using the “+” and “-” buttons you can now adjust the temperature for Segment 1 as desired. When you have adjusted the Temperature to the desired level, move to Segment 2 by pressing “>”. You will notice that the temperature bars of Segment 2 are displayed. Adjust the temperature for Segment 2 and once again press “>” this time to move to Segment 3. Continue this process until all the temperature settings are to your liking. You can now either save the Program or use “Enter” to move to the next parameter (Fan) and adjust the Fan speed for all the Segments.

Advanced Manual Control

For those looking for a more precise control over their roasts there are methods that can be used to modify the roast profile while the coffee is roasting. You can use the program outlined below to learn how to manually control a roast. This procedure will take a bit of practice and experience because you will need to predict the end of first crack, but with time and practice this method can help achieve superior results.

The following Program can be used to achieve a roast that is about 15:30 to 16:30 in length (depending on roast level desired):

SEG.	TEMP.	TIME	FAN
1	225	3:00	0
2	279	3:00	0
3	315	:01	0
4	333	:29	1
5	351	2:00	1
6	378	2:30	2
7	396	3:00	3
8	406	3:00	4

Total Program = 17:30

Begin the roast normally, allowing the roaster to preheat and add the beans when the KN-8828P-2K signals you to do so. Allow the roast to progress, controlled by the Program. First crack will begin at about 5:00 remaining and this is the time to pay closer attention *1. When first crack becomes active (at about 4:00 remaining) use the “-” control to lower the temperature to below its presently indicated level, thus turning off the heating element. Use the Segment display (you should be in Segment 7 at this time) to judge the set level compared to the current temperature. When first crack ends be sure to note the remaining amount of time.

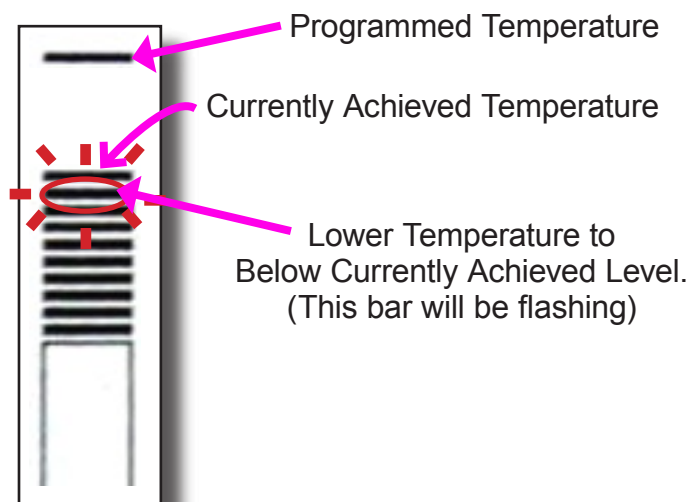

When Segment 7 ends and Segment 8 begins it may be necessary to lower the Segment temperature once again to maintain the current temperature. When about two minutes since the end of first crack has elapsed, use the “+” button to increase the temperature to its maximum for Segment 8. Second crack should begin at about 1:00 remaining in the programmed time. Allow the roast to progress to the level you desire and then manually eject the beans. For espresso eject the beans when second crack is “rolling” (very active) for about ten seconds. For other methods of brewing try ejecting the beans earlier in second crack. Experiment to find the taste that suits your brewing method and personal preferences.

Using the manual control to modify the roast and extend the time between first and second crack extends this critical development period in the roasting process, and will help you get the best from your coffee.

*1 - All times are estimates and will vary depending on total bean mass, ambient air temperature, ambient humidity, line voltage, condition of rear filter, whether the roaster was already heated from a previous roast, and other factors.

IX - Cleaning and Care

Roasting coffee can be a bit messy. The chaff that comes off the beans, bits and pieces of coffee beans, and stray beans themselves can get strewn about, in and out of the roaster. To create the best coffee possible, to ensure safe operation, and to extend the life of your Hottop Coffee Roaster, it is very important to do some regular maintenance and cleaning.

NOTE: Red numbers below in parentheses, (5) as an example, refer to the diagram on page 7

WARNING: All cleaning chores should only be done with the machine unplugged and when the machine has cooled to room temperature. After washing, allow all parts to thoroughly dry before assembling and before using the machine again!

A. AFTER EACH ROAST

WARNING: TO PREVENT FIRE, IT IS IMPORTANT THAT THE CHAFF TRAY (4) UNDERNEATH THE ROASTING DRUM IS FULLY EMPTIED AFTER EVERY ROAST!

Pull the chaff tray (4) out using the black plastic handle (located under the viewing window on the front of the machine). Use a soft brush, or kitchen towel to clean the tray. If required, wash the chaff tray with water and soap. Dry thoroughly before replacing.

IMPORTANT: These Coffee Roasters are equipped with a safety mechanism that makes it impossible to restart the machine until the chaff tray is removed, emptied, and replaced.

2. Some beans create more chaff than others. At times there can be a chaff build up inside the roasting chamber after just one roast. To clean out this stray chaff, remove the chaff tray (4), cooling tray (3), bean loading cover (2), and while holding the front cover (6) on the machine with one hand, unscrew the Gold Knob (5) and remove the Front Cover (6). Then carefully tip the Coffee Roaster forward and gently shake it to remove stray chaff. Carefully using a compressed air can will assist in removing the stray bits of leftover chaff and bean particles. Use caution so as not to displace the material contained in the Top Filter (13) when using compressed air. **WARNING:** proper eye protection and breathing protection should be used when using compressed air to clean out the roasting chamber.
3. To clean the glass viewing window, wait until the machine has completely cooled off and remove the chaff tray. While holding the front cover (6) on the machine with one hand, unscrew the Gold Knob (5), until the front cover to be easily lifted off. Use a soft cloth moistened with water to clean the glass. Encrusted oils on the glass can be removed using a stiff brush or wet nylon scouring pad with a small amount of dish washing soap. Scrub gently to avoid scratching the glass. Rinse thoroughly and allow to dry before replacing. Tough buildup can be removed with espresso machine cleaner or diluted TSP (tri-sodium phosphate). Rinse thoroughly and allow to completely dry before replacing cover.
4. Check the inside of the drum (9) after each roast. Beans can sometimes get stuck in the drum and if allowed to go thorough a subsequent roast they will bum. The burnt beans can affect the taste of the entire roast. Remove the front cover of the machine as described in step 3 above and look inside the drum. Stuck beans can be dislodged using a long-handled, stiff brush, a length of 1/4" wood dowel, chopstick, or similar tool. If necessary, remove the drum for cleaning (outlined below).
5. Replace the Main Filter (1) at the rear of the machine after 30-45 roasts.

B. AFTER 5 TO 10 ROASTS

1- Drum Removal (Refer to diagram on page 7)

NOTE: For all tasks related to disassembly or repair of the Hottop Bean Roaster, we urge you to refer to the Repair section of our website at www.hottopusa.com. There you will find photographic illustrations and detailed, step-by-step instructions to guide you.

Chaff and other small particles will accumulate in the roasting chamber after roasting. Large amounts of this dry material can ignite and start a fire inside the roaster. It is therefore very important to check the roasting chamber, and if necessary, remove the drum and clean the entire roasting chamber to be sure that chaff and other flammable particles are not building up in the roast chamber. The following procedure describes how to remove the drum.

IMPORTANT: Please take care when following this procedure to remove the drum.

You can damage the machine, which may void the warranty, or cause a hazard not covered by the warranty. Use care not to scratch the machine or damage the drum. It is heavy so take care when removing it. Also watch for sharp edges on the drum and front plate. Wearing gloves for this procedure is recommended.

- a. Start by removing the cooling tray (3), chaff-collecting tray (4), heat safety guards, and bean loading cover (2) Now unscrew the gold knob (5) and take the front cover (6) off, as described above. It is best to place all removed parts off to the side where they won't get knocked off the counter or into the sink.
- b. Remove the four Phillips head screws (7) on the front plate (8) and store these, for example, in the chaff tray (4). When the four screws have been removed, carefully pull the front plate (8) off the Coffee Roaster. Note that it is located on two small metal pins (11) on the front of the machine.
- c. The drum (9) can now be taken out of the roasting chamber by pulling it straight out. You may need to lift it slightly before pulling it out as its weight might jam it in the drive shaft once the front plate is removed.
- d. Clean out the chaff inside the roasting chamber (10) with a soft brush or cloth, or using a vacuum cleaner, which can be convenient to remove all chaff and dust inside the roasting chamber
- e. Some staining and discoloration is normal in the roasting chamber. For heavy build-ups of coffee oils use a rag LIGHTLY MOISTENED in a coffee machine cleaning solution. Wipe the chamber thoroughly with a rag or towel moistened with clean water to remove all traces of cleaning solution. Allow the machine to dry completely before replacing the drum.

WARNING: DO NOT ALLOW WATER OR CLEANING SOLUTION TO DRIP INTO OR FLOOD THE ROASTING CHAMBER! Water damage is not covered by the warranty.

- f. Over time the drum (9) can become excessively caked with coffee oils. A light coating is good, but if it smells burnt or rancid, or if the buildup is heavy it is time to clean it. The drum should be taken out of the roaster for thorough cleaning. An espresso machine cleaner can be used or the removed drum can be placed in the dishwasher. It is stainless steel and won't rust. Dry the drum thoroughly before replacing it in the Coffee Roaster. **WARNING:** NEVER immerse the entire machine in water and NEVER place the entire machine in the dishwasher.

2- Replacing the drum (Refer to diagram on page 7)

- a. Replace the drum (9) in the roasting chamber (10), being careful to align the drive pin on the drum's axle with the slot in the drive shaft. While keeping the drum parallel with the roasting chamber, push the drum until it is fully seated.
- b. Reposition the bearing plate (8). The flange on the edges of the Bearing Plate face outwards (towards you). Make sure that the two pins (11) on the front of the Coffee Roaster are aligned with the two small

holes in the front plate and that the drum shaft goes into the hole in the center of the front plate. Hold the Bearing Plate (8) in place and verify that it is fully seated on the front of the machine and that the alignment pins (11) are in their locating holes.

- c. While holding the Bearing Plate (8) aligned on the locating pins, replace the four screws (7) by hand and screw them in by hand until seated. Once the screws (7) are fully inserted, again verify that the end of the Roasting Drum's Axle (12) is properly located in the bearing hole in the Bearing Plate (8) and that the Alignment Pins (11) are in their respective alignment holes in the Bearing Plate (8). Carefully tighten the four screws with a screwdriver.

CAUTION: DO NOT OVER-TIGHTEN THE SCREWS!

- d. Put the Front Cover (6) back and screw in the Gold Knob (5) until lightly seated. Do not tighten the knob all the way. At the beginning of the next roast remember to adjust the Gold Knob until the Drum rotates smoothly and as quietly as possible.

3- Exterior cleaning

WARNING: Always wait until the machine is completely cool before cleaning, and always disconnect the power cord before cleaning.

The outside of the machine can be cleaned with a damp cloth. A small amount of household cleaner compatible with stainless steel can be used if necessary. Never use abrasive tools like steel wool pads, nylon scrubbing pads, etc., and never use abrasive cleaners such as kitchen cleanser. If the stainless steel cover has very stubborn spots, use a VERY MILD chrome polish. Afterwards, use a normal household cleaner to carefully remove all traces of wax or cleaner. Cleaning residue left on the hot surfaces of the roaster will burn when using the machine, and may produce toxic smoke, and/or leave stains. After cleaning, always allow the Coffee Roaster to dry completely before plugging in the power cord.

C - EVERY THREE MONTHS - INTERIOR CLEANING

WARNING: Always wait until the machine is completely cool before cleaning, and always disconnect the power cord before cleaning.

The rear main fan draws air and smoke out of the roasting chamber and this will contain some chaff and other coffee debris. Over time this material can accumulate in the electronics area in the rear of the machine and if allowed to accumulate this material can create a potential fire danger. At least once every three months this area should be cleaned. To do so:

- 1) Remove the bean chute cover and cooling tray. It also may help to remove the drum as the machine will be lighter and easier to handle.
- 2) Remove the rear main fan.
- 3) Remove the rear cover.
- 4) Tip the machine to allow as much of the debris to spill out as can be removed by gravity.
- 5) Using compressed air or canned air, blow out as much of the remaining coffee debris, chaff, and dust as possible from the main circuit board as well as the upper area around the main motor and ejection solenoid. Take care not to damage any electronic components.
- 6) Reassemble

Step by step, illustrated instructions on the disassembly procedure can be found on the Hottop USA website at www.hottopusa.com in the "Repair Procedures" section.

X - Roasting styles overview

This section contains a brief explanation of the various roasts you can achieve with the Hottop Coffee Roaster, and will give you a general idea of how roast level affects taste. There are numerous factors that affect the roast level at a given time or Program setting on the machine. These can include bean age, moisture level, bean size, line voltage fluctuations, and many more. At some roast levels as little as thirty seconds or even less can have a big effect on taste. Because of that use the following suggestions as starting places only. The best guide to preferred roast level is your taste!

Many people think that very dark roasted coffee is the best way to roast, or that coffee has to be roasted until it is oily to be good for espresso, but that is just not true. As mentioned before, for some brewing methods, a light roast retains more of the delicate flavors, and can give the coffee a wonderful taste that many people never get a chance to enjoy. Experiment and you will discover what you like best.

Cracks, Flavors and Roast Styles

Before first crack occurs, the coffee will often taste grassy, and can be very sour. You can find this out for yourself by light-roasting one batch to this extreme and tasting it. Coffee roasted this light has a hard, acidic bite that reminds one of sour citrus fruit. In the extremes, think grapefruit and you will not be very far off. Coffee roasted this light is usually not very agreeable to the majority of coffee drinkers. Up to this point most of the roasting time has been spent removing excess moisture from the beans.

The beginning of first crack is the time when the coffee is just entering the state where it becomes drinkable. The coffee will be crisp, and acidic - like a very dry wine. This roast style is generally called “Cinnamon”. Some coffees can be very nice when roasted this way, but most people prefer a roast that is a little darker when the coffee has a more developed flavor.

Between the time just at the end of first crack, and shortly before second crack begins, the taste-features of most coffees will be most prominent. Depending on the coffee, these natural flavours can be remarkable and probably unlike what you have ever tasted. The taste will be predominantly “coffee,” but behind that you can find hints of fruit, spice, chocolate, nuts, and in some varieties a pleasant leathery or oaky taste. This style of roast is often referred to as “city roast,” and is generally appreciated by a majority of coffee drinkers. It is quite suitable for drip coffee or press pot. Some “City” roasted coffees can also make a very nice espresso, or be used for siphon or vacuum brewers.

A “City” roast is one of the more difficult to achieve because you have to predict when second crack will occur and stop the roast somewhat before that point. With experience, and by keeping a detailed “roasting log,” you will learn to anticipate this point using the various tools and techniques discussed in this manual (sound, smell, appearance, and time). The temperature display of the Hottop Coffee Roaster will assist in finding that point (refer to page 19). The beginning of second crack is sometimes referred to as “City Plus.”

As the roast progresses into second crack, the acidity gradually lessens, while at the same time the body of the coffee becomes heavier. The natural flavors of the coffee beans are reduced in strength, but the coffee gains in sweetness. Coffee that is roasted about fifteen snaps into second crack is generally referred to as “Full City”. This is the style that most people prefer for siphon brewers, and espresso. The taste is very well balanced between acidic and bitter, natural flavors are retained, and the body makes for a very pleasant beverage. You may notice that a few of the beans have small spots of oil on them when they drop into the cooling tray, but these often disappear as the beans cool.

As you roast further into second crack and the surface becomes shiny, the coffee will obtain a distinctly bittersweet taste. This is often referred to as a “Viennese roast”, and some people like this for a cappuccino since the flavor cuts through milk quite effectively.

CAUTION: Be careful when you are roasting the beans this dark. Ten or fifteen seconds in roast time at this point can have a significant and dramatic affect on the taste of the coffee, and thirty extra seconds in this phase can easily be the difference between good coffee and a beverage that tastes burnt– a very unpleasant coffee taste.

The “Viennese” style is as dark as most people enjoy their coffee. As you become more proficient at roasting you may want to experiment and roast coffee this dark, or even a little darker. If you do, you

will see large drops of oil appear on the surface of nearly all the beans. The smoke produced now is quite dense, and has a sharp, pungent smell. The coffee usually acquires a similar sharp taste, with the flavor being predominantly “roast” and less that of “coffee.” Some people do enjoy this “French” style but if you are purchasing quality beans this level of roast removes a lot of the taste for which you have paid.

Roasting even darker, “Spanish” as the style is sometimes called, is not recommended because it will destroy most of the original flavor of the coffee, and few people appreciate the burned taste. Still, some coffee shops have made it their trademark. Give it a try, if only to find out if you like it.

CAUTION: Be very careful when trying to do very dark roasts.

Second crack marks a time when you have to be especially attentive. The darker you roast, the faster the roasting progresses, and when second crack has started, things can happen very quickly, and sometimes they are not good things. When roasting dark it is important to be ready with a finger near the “Eject” button to end the roast manually at a moment’s notice.

WARNING: If you start to see a lot of oil on the beans during the roast, if the sounds of second crack begin to slow after peak activity, or if the smoke begins to dramatically increase, immediately end the roast by hitting the “Eject” button. These are warning signs that the coffee is reaching a dangerous point. If you allow the roast to go much further it could burn the beans in the roaster or the beans can even catch fire! As you get more accomplished at roasting coffee using the Hottop Coffee Roaster you will be able to dark-roast if that is your taste preference.

Roast styles are summarized in the following table:

Roast color	Stage	Name of style	Appearance of Bean
Very light brown	End of drying	----	Dry
Light brown	Start of first crack	Cinnamon	Dry
Light-medium brown	First crack	Light	Dry
Medium-brown	End of first crack	City	Dry
Medium-dark brown	Start of second crack	Full city	Dry/shiny
Dark brown	Slow second crack	Viennese	Spots of oil
Very dark brown	Fast second crack	French	Very shiny/oily
Extremely dark brown	Fast second crack	Spanish	Wet with Oil

Be aware that these roast style names are general in nature. What qualifies as “City” to one person can be something a little lighter or darker to another.

As a general rule, to obtain a bright cup with more a subtle flavor, try a lower setting to get a lighter roast. This is very suitable for filter drip, or press pot coffee. To get less acidity and a heavier bodied coffee, use a higher setting for a darker roast in the range of a City to a Full City roast, which is usually more enjoyable for siphon brewing or espresso.

Although flavor is related to roast style, the result also depends greatly on the variety of beans you roast.

Experiment with Roasts

Some people have been led to believe that only dark-roasted coffee tastes good, or that beans have to be oily to make good espresso and this is just not true. Look at the chart above. Do you see “Espresso

roast” listed? No. That is because there is no such thing— espresso is a beverage, not a roast. With your Hottop Coffee Roaster you can now roast coffee any way you like. Be bold! Be daring! Experiment! There are tastes in coffee that are amazing, but many are lost if the coffee is roasted too dark.

For drip coffee, try roasting some quality Colombian and stopping the roast about fifteen to thirty seconds after first crack ends, and well before second starts. This coffee may look lighter than most of what you are accustomed to, but the taste will be a real treat, particularly if you let the coffee “rest” for a few days before brewing!

As time goes along and you become more proficient in your roasting and tasting, you will find that some coffees taste quite good roasted light while others taste better dark. Don’t be afraid to roast separately then combine two roasts to create a “blend.” Sometimes 75% of one coffee roasted light mixed with 25% of another (or the same coffee) roasted dark can create a delightful taste treat.

Coffee Varieties and Roast Styles

When we classify coffee we divide it into two main species- Arabica and Robusta. With very few exceptions, Robusta is a lower grade with a generally unpleasant taste. It is used predominantly in the low-cost commercial coffees found in supermarkets. Arabica coffees generally cost more, but have a much more pleasant and delicious taste.

Coffee is grown in tropical regions around the world. As you might expect, the flavor of these vary enormously from one country to another. Even coffees grown in various regions within the same countries can differ in taste. For example, coffee from Java is distinctly different from Sumatran, but both are called “Indonesian.” Even coffee from neighboring farms can have different tastes.

It is impossible to say which roast setting is “best” for a particular coffee. Coffees vary enormously; some are highly acidic by nature, and have a very strong taste, while others are fairly mild and delicate. We suggest that you try different beans, from different countries, at different roast levels, if only to discover and experience all that coffee has to offer. Perhaps you will be surprised to find that you enjoy a different style of roast and coffee than you had previously thought.

For example, try blending 75% Brazilian or Colombian with 25% Sumatran. This basic blend combines the smooth rich taste, typical of the South American coffees, with the deep earthy notes of the Indonesian coffees.

The only way to find out what tastes best to you is to roast a few batches of the same coffee at different styles, and see which you prefer. For your convenience we have added a few guidelines to help you decide what setting to try first.

There is no way for us to be able to accurately tell you what setting, time, or temperature to use. Coffee sold in one part of the world can have a very different moisture level from coffee in another part of the world. Small peaberry beans roast differently from larger beans. Old beans behave differently from fresher beans. Even the voltage of the electrical supply in your home affects the roast level or time needed for your preferred roast. And most importantly, how you are going to brew the coffee and your personal taste is the most important factor in how you should be roasting. So, where do you start?

For drip coffee, and particularly for most home machines, start with a roast at some point after the end of first crack but before second crack. For press pot or vacuum pot coffee, try a roast that falls slightly before or just after the start of second crack. For espresso, the most dynamic method of coffee extraction, try just as second crack becomes “active” (when the cracks of second become closer together and somewhat suddenly become more numerous).

Whenever roasting a variety of coffee that is new to you or from a new crop or vendor, and particularly when learning to use the Hottop Coffee Roaster, start with a mid-level roast level. Don’t hesitate to manually eject the beans if the roast is ready before the machine ejects the beans automatically, or you can add some time at the end of the roast using the “PLUS” button (KN-8828P-2K) or the Target Time (KN-8828B-2K). Make notes concerning this in your roasting log and use that to adjust the roasting time or the amount of beans the next time you roast this coffee.

As you learn the coffees you are using and how they roast, you can adjust the roast settings and adjustments so that you can get the roast you want. Day to day, roast times and temperature adjustments will vary even if you use the same exact amount of beans, from the same batch of green coffee, and roast at the same exact level. For that reason, to achieve the taste you want, you always need to carefully monitor your roasts to avoid incorrectly roasted coffee.

WARNING: Never leave the roaster unattended during a roast!

Central-American, Colombian and African Coffees

Although these coffees are very different in flavor, they are commonly very acidic, or “bright” like dry wines. Many people associate this with a “sour” taste. If you appreciate this quality in your coffee you may want to stop the roast just at the end of first crack or even a little sooner. For a smoother, more balanced taste, let the roast go to the first clicks of second crack.

Brazilian, Mexican and Other Mild Coffees

As the title says, these are generally very mild coffees, with low acidity. They are usually very nice when roasted to Medium-dark brown, between first and second crack, and can be used for drip coffee, siphon, and espresso.

Indonesian Coffees

Somewhat like Brazilian, Indonesian coffees are usually not as bright as other origins, and you may want to try these roasted lightly, at a low setting. This can be very good for filter drip, or siphon. If you find the flavor too strong, or if you enjoy espresso, try Medium-dark brown, or dark-brown roasted. These can vary widely in quality, so if you get one you do not like, try another source.

Sumatran, or Sulawesi Coffee.

These coffees usually are best roasted a bit on the dark side (“Full City”). On their own, their earthy taste is not to everyone’s liking, but they are wonderful for blending with other coffees. These also vary widely in quality, so choose your sources for these beans carefully.

What’s Best? You Decide!

All the above remarks are solely intended as starting points. If you are not satisfied with the results, change the roast setting on the next batch:

- Is the coffee too light? Try letting the roast go a little further next time. Possibly use a slightly smaller mass of beans.
- Is the coffee too dark? Try ending the roast manually a little earlier or when they look right to you.

Don’t be afraid to experiment with roast levels. Once you become familiar with the Hottop Coffee Roaster it will be easier to determine how to achieve the results you desire for a particular variety of coffee, how to judge the roast progress, and how to intervene if needed.

So what roast style is best for your coffee? Only you can decide! A lot depends on the variety or blend of the beans you are roasting and how it will be brewed (drip, press pot, siphon, espresso machine, etc.), Most importantly, of course, it depends on your own personal tastes. That is the joy of owning a Hottop Coffee Roaster; you decide what you like and roast to that level.

What roast style is best?

The one YOU like.

Feel free to experiment to find it!

The Hottop Coffee Roaster Makes That Easy!

XI - Tips and Hints

Storing Coffee

There has long been a debate as to the best way to store coffee. Green coffee is easy to store. Left in a cloth bag in a cool, dark, dry place, green coffee will keep for as long as a year with little difficulty. Placed in the back of a kitchen cabinet away from the dishwasher or stove will probably be just fine for quite some time. Cloth bags are best as they let the coffee breathe and they eliminate the possibility of condensation.

Roasted coffee is another matter all together. Once roasted the clock begins to tick. Whether kept in the refrigerator, in air-tight bags, packed in nitrogen, or vacuum packed, roasted coffee changes chemically over time and soon becomes stale. The best advice is to keep fresh-roasted coffee in a closed, sealed, glass container in a dark cool cabinet and try to use it relatively quickly. Fancy storage procedures like vacuum packing or packing in nitrogen might be slightly helpful in the short run, but once exposed to air the benefits these methods provide are soon lost.

For drip, coffee is best used in less than two weeks from the time it is roasted. For espresso, try to consume your roast within no more than about one week to ten days. As you become accustomed to having fresh coffee you will be able to easily taste the difference between freshly roasted coffee and that which has been stored too long. One benefit of home roasting is that you can roast only as much as you need for about a week and never have to taste stale coffee again.

There are some exceptions to this. Some coffees, such as monsooned Malabar coffee from India, benefit from a rest period of as much as ten day to two weeks after roasting. As you use different coffee, pay attention to how they taste over time. If you find they taste better as the last of the roast is about to be used up than when fresher, try allowing a longer rest period for the next batch before you brew them.

Back to Back Roasts

If the roaster has not cooled sufficiently after the last roast cycle it will not be possible to start a new cycle right away. If you attempt to restart the Coffee Roaster when it is too hot it will automatically go into the cooling mode until the machine has cooled sufficiently. This is evidenced by the rotation of the agitation arms in the cooling tray and the fans running.

When the machine has reached the appropriate temperature, it will start beeping to signal you that it is time to add the coffee as described earlier. At this time you can proceed by filling the machine with beans, and continue a normal roasting cycle. This protects the machine from overheating and the beans from being scorched by being added to a too-hot drum.

Roasting Tips

A lot of factors can affect the roast level of the coffee but there are some things you can do to fine-tune your roast. If the roasted coffee comes out too light try using a longer program or adding “Plus” time on the KN-8828P-2K, or program more initial time into the KN-8828B-2K. You can also reduce the batch size from 250 to 225 grams of beans. If, on the other hand, the roasted coffee comes out too dark, try increasing the batch size to 270 grams or decreasing the roast time. Experiment with different roast times and batch sizes to find the taste that you like and the amount of coffee you can use before it begins to lose flavor.

If a batch of coffee is ejected accidentally during the roast but is not dark enough it is best to discard the beans. Coffee goes through a chemical process during the roasting cycle and this reaction cannot be repeated- you get one chance. It would be like trying to unscramble, then re-scramble an egg. It just can't be done.

Dark and Decaf Coffee

Be careful when roasting very dark. When you reach second crack, the cracks first increase in pace, become quite active, then decrease again. If you hear the frequency and number of the cracks during second crack begin to slow down it is a warning that must not be ignored. The beans are about to be burnt, and if the roasting is not stopped, it has the potential to become a fire hazard. Learn to listen for the cracks and use them to help you achieve perfect roasts.

Roasting decaffeinated coffee is more difficult than roasting “regular” coffee. The decaffeination process makes the color of the beans more difficult to discern and the cracks occur in much reduced numbers. For this reason, we highly recommend learning to roast with “regular” coffee before attempting to roast decaf.

CAUTION: Be very careful when trying to do very dark roasts.

Second crack marks a time when you have to be especially attentive. The darker you roast, the faster the roasting progresses, and when second crack has started, things can happen very quickly, and sometimes they are not good things. When roasting dark it is important to be ready with a finger near the “Eject” button to end the roast manually at a moment’s notice.

WARNING: If you start to see a lot of oil on the beans during the roast, if the sounds of second crack begin to slow after peak activity, or if the smoke begins to dramatically increase, immediately end the roast by hitting the “Eject” button. These are warning signs that the coffee is reaching a dangerous point. If you allow the roast to go much further it could burn the beans in the roaster or the beans can even catch fire! As you get more accomplished at roasting coffee using the Hottop Coffee Roaster you will be able to dark-roast if that is your taste preference.

Bean Cleaning

When the roast is over, and the beans are sitting in the cooling tray, you may notice that some stray chaff is left on the beans. This is normal. Some coffee grinders don’t control static electricity well and the leftover chaff can add to the mess. Also, some people just don’t like the looks of the chaff in their beans. An effective tool to remove most of the stray chaff is a pasta strainer or colander. Manually agitating the beans in one of these allows the chaff and small bits of beans to fall away leaving clean coffee. To protect your grinder, while agitating the beans it is recommended to watch for small rocks and other foreign matter that is sometimes found in green coffee. Remove and discard these.

When Is It Ready to Drink?

Depending on the beans, the roast level, the brewing method you use, and your personal tastes, some beans are best after they are allowed to “rest” for a day or two before use. Their taste develops and changes in this first day or two after roasting. For espresso this can be very important. For other methods of brewing it may not be so. How do you know? Experiment! Only you know what tastes best to you! Roast a batch of Colombian to about thirty seconds after first crack ends and use it right away, and for the next few days. Your palate will soon begin to show you what you like.

How to Taste-Test Coffee

An excellent method for tasting coffee is the way you normally drink it, but coffee experts “cup” the coffee. This is an art in itself, but you can get a good idea about the coffee by doing it at home. You will need a source of quality water, a kettle in which to boil it, an eight ounce, heat-resistant cup with a wide opening and straight sides, and a deep tablespoon. Take the coffee right from the roaster after it has cooled, grind some in your grinder, and put a coffee-measure full into the cup. After the water just reaches boil, take the water off the heat source and count about ten seconds, then pour about 6 ounces of water into the cup. Allow the coffee to soak for a bit, then break the “crust” with the spoon and inhale the aroma through your nose, long and deep. The aroma of brewing coffee tells a lot about how it will taste.

Now, fill your spoon with coffee (avoiding the grounds as much as is possible). Now, the trick is to “slurp” the coffee into your mouth so that it sprays the spoonful into all parts of your mouth all at once.

You may wish to practice with some plain, cool water first, and please be careful not to burn yourself with the hot coffee! It is sort of like a powerful kiss, but take care to avoid drawing coffee into your throat.

When tasting coffee this way pay attention to how it tastes at the very first, immediately after it coats your mouth, and how it tastes after it is swallowed. Repeat this a few times until you get an idea of how it tastes. Additionally, rub the coffee between the tongue and the roof of your mouth to get a “feel” for it. This is the “Body” of the coffee how it feels without considering the taste. If you are tasting more than one type of coffee (an excellent experiment, by the way) be sure to rinse the spoon in one cup of clean water and take a sip of cool water from a different cup before switching coffees.

Don’t get discouraged. Tasting coffee in this way is a difficult skill, learned over time. As you become more proficient at it you will gain an important skill that can give you immediate feedback as to the quality of your roast.

My Coffee Doesn’t Taste Right To Me

Adjusting the taste of the coffee is something with which a lot of people struggle. If we accept that the coffee itself is good, then examine the brewing method. Many home drip machines brew at too cold of a temperature to make good coffee. Consider a manual pour-over cone or a press pot (“French Press”) as these “low tech” methods allow you to control the brewing temperature and can actually make better coffee than many of the modern drip machines found in most homes.

If the coffee is too bitter many people will reduce the amount of coffee they use per cup. That is the opposite of what you need to do. In most cases, the solution to a bitter beverage is to use more coffee! Start with one coffee-measure full of ground coffee to six ounces of water. If that is too bitter, try a little more coffee in the ratio. Experiment! There is no rule. Even try two measures in eight ounces. It makes for a strong, rich, full-bodied cup of coffee. Maybe not to your liking, but give it a try!

Bitterness also comes from over-roasted coffee. Roast too dark and a lot of the elements that “mask” the bitterness are burned away or changed chemically so the bitterness becomes dominant, and that is not a pleasant taste to most people. The solution? Roast lighter next time!

A good way to learn how the level of roast affects the taste of the beverage is to purposely under-roast a batch of coffee and taste it. Do much the same with an over-roasted batch, but use great caution when roasting dark! Try a batch that is done to just the very beginning of first crack and another to just as first crack ends. The experience gained here will help educate your palate to the different tastes that come from roasting and will help you understand the tastes you experience in the future. Additionally, some coffees like to be roasted light and others dark so doing such experiments over time with all the coffees you like is a good idea.

Good water is also important. If the water tastes bad or is too hard, it can affect the taste of the coffee. Try some bottled drinking water and see if that improves the taste.

Keep Records

Every professional roaster keeps a roasting book and guards it carefully, often keeping it locked away in a safe. In this log are roasting notes documenting the various roasting sessions and blends of beans used over the years. Some do it for every single roast, to the point of documenting the specific estates where the beans were grown and what crop-year they came from. We are not saying you need such detailed records, but keeping track of your roasts is important so that when you find a coffee, a coffee blend, and a matching roast that you like you can duplicate it later on.

Use the log to also write down to whom you give coffee and what they thought of it as well. A month from now when a friend says, “Remember that coffee you gave me?” You will be able to say “Yes! I do!”

Get a loose-leaf notebook and begin your “roasting log” now. If you think of it as a coffee roasting diary you begin to get the idea. Over time these records will be an invaluable resource to you.

XII - Resources

Hottopusa.com

For specific information not contained in this manual visit our website:

www.hottopusa.com

There you will find a lot of information including a troubleshooting guide, and an FAQ filled with lots of hints and tips. There is also a complete repair guide should you decide to undertake repairs on your own. **Be aware that you should always consult with us before attempting repair on any machine still under warranty.**

The Internet

The next best place to find information on just about any subject is the Internet and coffee is no exception. Use your favorite search engine to find information about coffee. Try some of the following search topics:

- Green Coffee beans
- Home coffee roasting
- How to make coffee
- Pour over cone
- Also search for your favorite coffee such as “Colombian coffee” or “Sumatran coffee”
- Home roasting
- Coffee roasting forum
- French press or Press pot
- Hottop roaster

When you enter any one of those search topics be prepared to be offered thousands of Internet sites. It reflects how popular fine coffee has become and how many people, like you, are looking for something better in the way of coffee. There are also numerous online forums dedicated specifically to home coffee roasting.

Suppliers of Beans

The first place to look for green coffee is locally. If you live in or near a city look for “Coffee roasters” in the yellow pages. Many will be glad to sell you green coffee, and beyond that, coffee roasters tend to be a friendly bunch and are often willing to discuss the art of roasting coffee, particularly with customers who show an interest. After you have a dozen or so roasting sessions under your belt and have a better idea of what is going on, strike up a conversation with your local roaster. Don’t expect to learn any “secrets” about their proprietary blends though. Those are generally a closely guarded secret.

After that, the best place to find green beans is by mail order through the Internet. Do a search for “green coffee” or “coffee beans” and you will see that there are a large number of suppliers out there. You will be amazed at how many different coffees there are from which to choose. When getting started don’t pick too many. Start with enough coffee to roast three or four batches each (about two pounds) of three or four different coffees. It will be easier and less confusing to learn what they taste like that way. Some offer sample packs, so that may be a good starting place when evaluating a new source.

Environmental Disposal



Do not dispose of electrical appliances as unsorted municipal waste, use separate collection facilities. Please contact your local government for information regarding the collection systems available. If electrical appliances are disposed of in landfills or dumps, hazardous substances can leak into the groundwater and get into the food chain, damaging your health and well-being. When replacing old appliances with new ones, the retailer is legally obligated to take back your old appliance for disposal.

PROGRAM NAME: _____ PROGRAM #: _____ DATE: _____ TOTAL TIME: _____

Segment #	1	2	3	4	5	6	7	8
Temperature								
Time								
Fan								

PROGRAM NAME: _____ PROGRAM #: _____ DATE: _____ TOTAL TIME: _____

Segment #	1	2	3	4	5	6	7	8
Temperature								
Time								
Fan								

PROGRAM NAME: _____ PROGRAM #: _____ DATE: _____ TOTAL TIME: _____

Segment #	1	2	3	4	5	6	7	8
Temperature								
Time								
Fan								

Roast Number: _____

Date: _____

Time: _____

Coffee Used:		First Crack Begin:	
		First Crack End:	
Program Name Temp/Time		Second Crack Begin:	
Ambient Temperature		Roast Style	
Roasting Notes:		Total Roast Time: manual / auto eject (circle one)	
		Cupping Notes:	

Roast Number: _____

Date: _____

Time: _____

Coffee Used:		First Crack Begin:	
		First Crack End:	
Program Name Temp/Time		Second Crack Begin:	
Ambient Temperature		Roast Style	
Roasting Notes:		Total Roast Time: manual / auto eject (circle one)	
		Cupping Notes:	

NOTES:



Hottop Coffee Roaster Owner's Manual

This manual covers the following models:
KN-8828B-2K and KN-8828P-2K



Manufactured by Chang Yue Industrial Corp.®
No. 170, Chung Lun, Chung Sha Tsun, An Ding Shian
Tainan, Taiwan
Tel: 886-6-593-2311 Fax: 886-6-593-4834
www.hottop.com.tw
Email: hottop@ms12.hinet.net

Hottop USA
25 Katelan Court
Cranston, Rhode Island 02921
Fax: (401) 946-0268
www.hottopusa.com
Email: hottop@hottopusa.com